

## Section 2: Safety Switches

### GE Fastrac Program Service

#### Safety Switches

The GE Fastrac Program includes popular heavy duty and general duty safety switches.

Standard cycle: 5 days

**GE Fastrac Program:** Distributor stock

For more information on these products, order publications from Sections 21 and 22.

Quick Selection Guide, Enclosure Types.....	2-2
General Duty, Type TG .....	2-4
Heavy Duty, Type TH.....	2-6
Mill Duty, Type TH .....	2-14
Double Throw Switches, Type TC, TDT .....	2-17
Special Purpose, Heavy Duty, Type TH .....	2-20
Definite Purpose .....	2-23
AC Disconnects .....	2-24
Accessories: NEMA Type 1 and 3R Enclosures.....	2-25
Accessories: NEMA Type 4/4X and Mill Duty Enclosures.....	2-27
Additional Accessories.....	2-29
Enclosure and Knockout Dimensions.....	2-31 through 2-39
Low Voltage Construction Fuses .....	2-40

**Publications and Reference:** See Section 21 for a list of additional product-related publications



# Spec-Setter Safety Switches

## Quick Selection Guide

### General Duty Safety Switch, Single-throw

Max. System Voltage	Ampere Rating	Switch Type	UL Listed Fusing		Enclosure Type	BuyLog Page
			Class	Withstanding Rating (rms Sym Amps)		
250Vac 250Vdc	30-200	Fusible	K	10,000	1 3R	2-4, 2-5
			H	10,000		
			R	100,000		
			K	10,000		
			H	10,000		
			R	10,000		
	400-600	No <sup>1</sup> Fuse	R	100,000		
			K	10,000		
			H	10,000		
			R	10,000		
			K	10,000		
			R	10,000		



TG3321

### Heavy Duty Safety Switch, Single-throw

Max. System Voltage	Ampere Rating	Switch Type	UL Listed Fusing		Enclosure Type	BuyLog Page
			Class	Withstanding Rating (rms Sym Amps)		
600Vac 250Vac	30-1200	Fusible	H	10,000	1 3R 4/4X 5,12 Mill Duty	2-6 through 2-16
			R	200,000		
			J	200,000		
			L <sup>3</sup>	100,000		
			H	10,000		
			R	10,000		
		No <sup>1</sup> Fuse	J	10,000		
			L <sup>3</sup>	10,000		



TH3361SS

### Double-throw Safety Switch

Max. System Voltage	Ampere Rating	Switch Type	UL Listed Fusing		Enclosure Type	BuyLog Page
			Class	Withstanding Rating (rms Sym Amps)		
600Vac 250Vdc	30-600	No Fuse	—	—	1 <sup>2</sup>	2-17 through 2-19

<sup>1</sup>Non-fusible switch withstand ratings apply when protected by corresponding listed fuse type.

<sup>2</sup>100-200 amp also available as Type 3R (General Duty only).

<sup>3</sup>Class L fuses are only applicable when used with 800 and 1200A Type TC safety switches.

### Enclosure Types

**Type 1**—Enclosures constructed for indoor use to provide a degree of protection to personnel against incidental contact with the enclosed equipment and to provide a degree of protection against falling dirt.

**Type 3R**—Enclosures constructed for either indoor or outdoor use to provide a degree of protection to personnel against incidental contact with the enclosed equipment; to provide a degree of protection against falling dirt, rain, sleet, and snow; and that will be undamaged by the external formation of ice on the enclosure

**Type 4**—Enclosures constructed for either indoor or outdoor use to provide a degree of protection to personnel against incidental contact with the enclosed equipment; to provide a degree of protection against falling dirt, rain, sleet, snow, windblown dust, splashing water, and hose-directed water; and that will be undamaged by the external formation of ice on the enclosure.

**Type 4X**—Enclosures constructed for either indoor or outdoor use to provide a degree of protection to personnel against incidental contact with the enclosed equipment; to provide a degree of protection against falling dirt, rain, sleet, snow, windblown dust, splashing water, hose-directed water, and corrosion; and that will be undamaged by the external formation of ice on the enclosure.



TC10323R



# Spec-Setter Safety Switches

## Quick Selection Guide

### Enclosure Types (continued)

**Type 5**—Enclosures constructed for indoor use to provide a degree of protection to personnel against incidental contact with the enclosed equipment; to provide a degree of protection against falling dirt; against settling airborne dust, lint, fibers, and flyings; and to provide a degree of protection against dripping and light splashing of liquids

**Type 12**—Enclosures constructed (without knockouts) for indoor use to provide a degree of protection to personnel against incidental contact with the enclosed equipment; to provide a degree of protection against falling dirt; against circulating dust, lint, fibers, and flyings; and to provide a degree of protection against dripping and light splashing of liquids

**Application Note:** For applications of disconnecting means in motor circuit applications, disconnect must be sized based on ampacity per NEC 430-110, but not less than 115% of Motor Name-Plate current.

### Comparison of Specific Applications of Enclosures for Indoor Nonhazardous Locations

Provides a Degree of Protection Against the Following Environmental Conditions	Type of Enclosure				
	1*	4	4X	5	12
Incidental contact with the enclosed equipment	X	X	X	X	X
Falling dirt	X	X	X	X	X
Falling liquids and light splashing	-	X	X	X	X
Circulating dust, lint, fibers, and flyings**	-	X	X	-	X
Settling airborne dust, lint, fibers, and flyings**	-	X	X	X	X
Hosedown and splashing water	-	X	X	-	-
Oil and coolant seepage	-	-	-	-	X
Corrosive agents	-	-	X	-	-

\*These enclosures may be ventilated.

\*\* These fibers and flyings are nonhazardous materials and are not considered Class III type ignitable fibers or combustible flyings. For Class III type ignitable fibers or combustible flyings see the National Electrical Code, Article 500.

### Applications of Enclosures for Outdoor Nonhazardous Locations

Provides a Degree of Protection Against the Following Environmental Conditions	Type of Enclosure		
	3R*	4	4X
Incidental contact with the enclosed equipment	X	X	X
Rain, snow, and sleet**	X	X	X
Windblown dust, lint, fibers, and flyings	-	X	X
Hosedown	-	X	X
Corrosive agents	-	-	X

\*These enclosures may be ventilated.

\*\* External operating mechanisms are not required to be operable when the enclosure is ice covered.

<b>T H N 3 3 6 1 J DC</b>									
<b>Publication</b>									<b>Other Features</b>
<b>Duty Level</b>									DC= Max DC Voltage-600V
H= Heavy Duty									CL= Copper Lug
G= General Duty									
C= Double Throw									<b>Enclosure Type</b>
D= Fusible Double Throw									Blank= NEMA 1
									B= Bottom Feed (240V, TH, Type 1, 200-600A)
<b>Fusing</b>									R= NEMA 3R
N= No Fuse									SS= NEMA 4/5 Stainless Steel Type 304
Blank= Fused									SS317= NEMA 4/4X Stainless Steel Type 317
									J= NEMA 12
<b>Number of Wires</b>									M= Mill Duty NEMA 12
2, 3, 4, 6									W= Viewing Window Option
									F= Vertically Hinged Door, NEMA 3R
<b>Number of Poles</b>									
2, 3, 6									<b>Ampere Rating</b>
									1= 30A
									2= 60A
									3= 100A
									4= 200A
									5= 400A
									6= 600A
									<b>Maximum AC Voltage</b>
									2= 240V, 6= 600V

**Publications and Reference:** See Section 21 for a list of additional product-related publications



## General Duty, Type TG

Spec-Setter Safety Switches

30-600 Amperes

240 Volts AC

250 Volts DC

### Cartridge Fuse, Type TG Switches

- Designed for residential or light commercial application where duty is not severe.
- UL Listed. Products in this section have been tested by UL and shown to meet the construction and performance requirements of UL Standard Number 98, Enclosed and Dead Front Switches.
- Meet or exceed NEMA Enclosed Switch Standard KS1-1990 for Type GD.
- CSA certified.
- 60°C and 75°C conductor rating.
- Feature quick-make, quick-break mechanisms (30-200 amps).
- Suitable for use as service entrance equipment when installed in accordance with National Electrical Code.
- 30-200 amp fusible switches are rated 100,000 rms amps, sym IC when used with Class R fuses.  
Order appropriate Class R Fusing Kit from pages 2-29 and 2-30.
- Bottom-feed version available for 200-600 amp, NEMA 1 only.

### Reference Publications

Descriptive Bulletin	GEA-12144
Replacement Parts Bulletin	GEF-4452

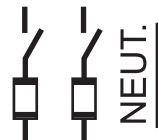

Fusible, Two-pole, 120/240 and 240 Volts ac; 250 Volts dc (30-100 amps only); Three-wire SN, 240 Volts ac

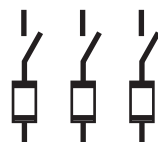

Fusible, Three-pole, 240 Volts ac

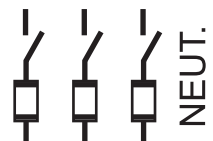

Fusible, Four-wire SN, 208/120 and 240 Volts ac

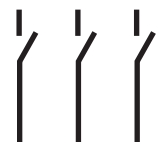

No Fuse, Two-pole, 240 Volts ac; 250 Volts dc (30-100 amps only); Three-pole, 240 Volts ac or Two-pole with Switching Neutral



Accessories and Lug Sizes: See pages 2-25 to 2-30  
 Outlines, Dimensions and Knockouts: See pages 2-31 to 2-39

# General Duty, Type TG

## Spec-Setter Safety Switches

30-600 Amperes

240 Volts AC

250 Volts DC

### Fusible, Two-pole, 120/240 and 240 Volts ac; 250 Volts dc (30-100 amps only); Three-wire SN, 240 Volts ac GO-131A

Ampere Rating	Enclosure Type	HP, 240 Vac, NEC Std, 1-ph	HP, 240 Vac, NEC Std, 3-ph	HP, 240 Vac, Time Delay, 1-ph	HP, 240 Vac, Time Delay, 3-ph	HP, 125 Vdc	HP, 250 Vdc	Product Number	List Price
30A	NEMA Type 1	1 1/2	3	3	7 1/2	2	5	TG3221 <sup>1</sup>	\$77.00
60A	NEMA Type 1	3	7 1/2	10	15	3	10	TG3222	\$135.00
100A	NEMA Type 1	7 1/2	15	15	30	-	20	TG3223	\$277.00
200A	NEMA Type 1	15	25	15	50	-	-	TG3224	\$579.00
400A	NEMA Type 1	-	50	-	100	-	-	TG3225	\$1628.00
600A	NEMA Type 1	-	75	-	100	-	-	TG3226	\$3253.00
30A	NEMA Type 3R	1 1/2	3	3	7 1/2	2	5	TG3221R	\$124.00
60A	NEMA Type 3R	3	7 1/2	10	15	3	10	TG3222R	\$213.00
100A	NEMA Type 3R	7 1/2	15	15	30	-	20	TG3223R	\$313.00
200A	NEMA Type 3R	15	25	15	50	-	-	TG3224R	\$779.00
400A	NEMA Type 3R	-	50	-	100	-	-	TG3225R	\$2197.00
600A	NEMA Type 3R	-	75	-	100	-	-	TG3226R	\$4167.00

### Fusible, Three-pole, 240 Volts ac GO-131A

Ampere Rating	Enclosure Type	HP, 240 Vac, NEC Std, 1-ph	HP, 240 Vac, NEC Std, 3-ph	HP, 240 Vac, Time Delay, 1-ph	HP, 240 Vac, Time Delay, 3-ph	HP, 125 Vdc	HP, 250 Vdc	Product Number	List Price
30A	NEMA Type 1	1 1/2	3	3	7 1/2	-	5	TG4321 <sup>1</sup>	\$126.00
60A	NEMA Type 1	3	7 1/2	10	15	3	10	TG4322	\$213.00
100A	NEMA Type 1	7 1/2	15	15	30	-	20	TG4323	\$366.00
200A	NEMA Type 1	15	25	15	50	-	-	TG4324	\$788.00
400A	NEMA Type 1	-	50	-	100	-	-	TG3325	\$1737.00
600A	NEMA Type 1	-	75	-	100	-	-	TG3326	\$3482.00
30A	NEMA Type 3R	1 1/2	3	3	7 1/2	-	5	TG4321R	\$193.00
60A	NEMA Type 3R	3	7 1/2	10	15	3	10	TG4322R	\$286.00
100A	NEMA Type 3R	7 1/2	15	15	30	-	20	TG4323R	\$527.00
200A	NEMA Type 3R	15	25	15	50	-	-	TG4324R	\$957.00
400A	NEMA Type 3R	-	50	-	100	-	-	TG3325R	\$2251.00
600A	NEMA Type 3R	-	75	-	100	-	-	TG3326R	\$4857.00

### Fusible, Four-wire SN, 208/120 and 240 Volts ac GO-131A

Ampere Rating	Enclosure Type	HP, 240 Vac, NEC Std, 1-ph	HP, 240 Vac, NEC Std, 3-ph	HP, 240 Vac, Time Delay, 1-ph	HP, 240 Vac, Time Delay, 3-ph	HP, 125 Vdc	HP, 250 Vdc	Product Number	List Price
30A	NEMA Type 1	1 1/2	3	3	7 1/2	-	5	TG4321 <sup>1</sup>	\$126.00
60A	NEMA Type 1	3	7 1/2	10	15	3	10	TG4322	\$213.00
100A	NEMA Type 1	7 1/2	15	15	30	-	20	TG4323	\$366.00
200A	NEMA Type 1	15	25	15	50	-	-	TG4324	\$788.00
400A	NEMA Type 1	-	50	-	100	-	-	TG4325	\$1985.00
600A	NEMA Type 1	-	75	-	100	-	-	TG4326	\$3704.00
30A	NEMA Type 3R	1 1/2	3	3	7 1/2	-	5	TG4321R	\$193.00
60A	NEMA Type 3R	3	7 1/2	10	15	3	10	TG4322R	\$286.00
100A	NEMA Type 3R	7 1/2	15	15	30	-	20	TG4323R	\$527.00
200A	NEMA Type 3R	15	25	15	50	-	-	TG4324R	\$957.00
400A	NEMA Type 3R	-	50	-	100	-	-	TG3325R <sup>2</sup>	\$2251.00
								TN165	\$232.00
600A	NEMA Type 3R	-	75	-	100	-	-	TG3326R <sup>2</sup>	\$4857.00
								TN166	\$232.00

### No Fuse, Two-pole<sup>4</sup>, 240 Volts ac; 250 Volts dc (30-100 amps only); Three-pole, 240 Volts ac or Two-pole with Switching Neutral GO-131A

Ampere Rating	Enclosure Type	HP, 240 Vac, NEC Std, 1-ph	HP, 240 Vac, NEC Std, 3-ph	HP, 240 Vac, Time Delay, 1-ph	HP, 240 Vac, Time Delay, 3-ph	HP, 125 Vdc	HP, 250 Vdc	Product Number	List Price
30A	NEMA Type 1	3	7 1/2	3	7 1/2	-	5	TGN3321 <sup>1</sup>	\$102.00
60A	NEMA Type 1	10	15	10	15	3	10	TGN3322 <sup>3</sup>	\$135.00
100A	NEMA Type 1	15	30	15	30	-	20	TGN3323 <sup>3</sup>	\$313.00
200A	NEMA Type 1	15	50	15	50	-	-	TGN3324	\$579.00
400A	NEMA Type 1	-	100	-	100	-	-	TGN3325	\$1397.00
600A	NEMA Type 1	-	100	-	100	-	-	TGN3326	\$2667.00
30A	NEMA Type 3R	3	7 1/2	3	7 1/2	-	5	TGN3321R	\$193.00
60A	NEMA Type 3R	10	15	10	15	3	10	TGN3322R <sup>3</sup>	\$286.00
100A	NEMA Type 3R	15	30	15	30	-	20	TGN3323R <sup>3</sup>	\$527.00
200A	NEMA Type 3R	15	50	15	50	-	-	TGN3324R	\$957.00

For Type 1 Enclosure: 200-600 amp devices available factory reversed for bottom feed. Add "B" suffix to product number (e.g., TG3224B). List Price adder \$44.00, GO-131A. UL Listed.  
 For Type 3R Enclosure: 30-200 amp devices have removable closing cap. Order hubs for these devices separately on page 2-30. Larger amp devices require field cut openings and customer-supplied hub.

NEMA Type 3R No Fuse versions, 400-600 ampere rating, available in heavy duty, type TH models.

<sup>1</sup>Packaged five per carton.

<sup>2</sup>For 4 wire applications order neutral kit separately. See page 2-25.

<sup>3</sup>Not suitable for use as service equipment. Solid neutral not available.

<sup>4</sup>Use three-pole switch for two-pole application.

**Publications and Reference:** See Section 21 for a list of additional product-related publications



## Heavy Duty, Type TH

Spec-Setter Safety Switches

30-1200 Amperes

240 Volts AC

250 Volts DC

### Cartridge Fuse, Type TH Switches

- Designed for applications where safety, high performance and continuity of service are required.
- UL Listed. Products in this section have been tested by UL and shown to meet the construction and performance requirements of UL Standard Number 98, Enclosed and Dead Front Switches.
- CSA Certified.
- Meet Federal Specification WS-865C for heavy duty switches.
- Meet major automotive manufacturer's and JIC electrical specifications.
- Meet NEMA Enclosed Safety Switch Standard KS1-1990 for Type HD.
- Full cover interlocks.
- 60°C and 75°C conductor ratings.
- Quick-make, quick-break mechanisms.
- Suitable for use as service entrance equipment when installed in accordance with the National Electrical Code.
- UL Listed ratings for fusible switches when used with these fuses:
  - Class H (10,000 rms amps, sym IC). Standard on 30-600 amps.
  - Class L (100,000 rms amps, sym IC). Only applicable when used with 800 and 1200 amp Type TC Safety Switches (e.g. TC72367)
  - Class J (200,000 rms amps, sym IC). See page 2-29 for field conversion details.
  - Class R (200,000 rms amps, sym IC). Order appropriate Class R fusing kit from page 2-29.
- Safety switch product numbers with suffix "SS" are grade 304 stainless steel. Product numbers with suffix "SS317" are grade 317 stainless steel.

### Type TH Interrupting and Withstandability Ratings

Ampere Rating	Interrupting Rating Amps Symmetrical 600 volts AC, 3-phase	Fuse Clearing
30A	360	50
60A	1200	200
100A	1200	500
200A	3,400	2,000
400A	10,000	6,000
600A	10,000	12,000

### Reference Publications

Descriptive Bulletin	GEA-12144
Replacement Parts Bulletin	GEF-4452



Fusible, Two-pole, 240 Volts ac; 250 Volts dc

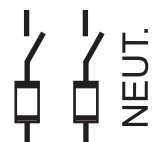

Fusible, Three-wire SN, 120/240 and 240 Volts ac

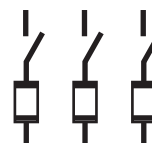

Fusible, Three-pole, 240 Volts ac

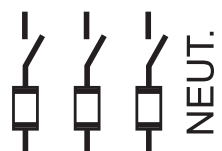

Fusible, Four-wire SN, 208/120 and 240 Volts ac



Accessories and Lug Sizes: See pages 2-25 to 2-30  
 Outlines, Dimensions and Knockouts: See pages 2-31 to 2-39

**Heavy Duty, Type TH**  
**Spec-Setter Safety Switches**  
**30-1200 Amperes**  
**240 Volts AC**  
**250 Volts DC**

Fusible, Two-pole, 240 Volts ac; 250 Volts dc									GO-131
Ampere Rating	Enclosure Type	HP, 240 Vac, NEC Std, 1-ph	HP, 240 Vac, NEC Std, 3-ph	HP, 240 Vac, Time Delay, 1-ph	HP, 240 Vac, Time Delay, 3-ph	HP, 125 Vdc	HP, 250 Vdc	Product Number	List Price
30A	NEMA Type 1	1 1/2	3	3	7 1/2	-	5	TH3221	\$153.00
60A	NEMA Type 1	3	7 1/2	10	15	5	10	TH3222	\$300.00
100A	NEMA Type 1	7 1/2	15	15	30	-	20	TH3223	\$467.00
200A	NEMA Type 1	15	25	-	60	-	40	TH3224	\$830.00
400A	NEMA Type 1	-	50	-	125	-	50	TH3225	\$1948.00
600A	NEMA Type 1	-	75	-	200	-	-	TH3226	\$3670.00
800A	NEMA Type 1	-	-	-	-	-	-	TC72267 <sup>1,3</sup>	\$6996.00
1200A	NEMA Type 1	-	-	-	-	-	-	TC72268 <sup>1</sup>	\$9614.00
30A	NEMA Type 3R	1 1/2	3	3	7 1/2	-	5	TH3221R	\$291.00
60A	NEMA Type 3R	3	7 1/2	10	15	5	10	TH3222R	\$542.00
100A	NEMA Type 3R	7 1/2	15	15	30	-	20	TH3223R	\$702.00
200A	NEMA Type 3R	15	25	-	60	-	40	TH3224R	\$1006.00
400A	NEMA Type 3R	-	50	-	125	-	50	TH3225R	\$2450.00
600A	NEMA Type 3R	-	75	-	200	-	50	TH3226R	\$4590.00
800A	NEMA Type 3R	-	-	-	-	-	-	TC72267R <sup>2,3</sup>	\$8975.00
1200A	NEMA Type 3R	-	-	-	-	-	-	TC72268R <sup>2</sup>	\$13127.00
30A	NEMA Type 4/4X	1 1/2	3	3	7 1/2	-	5	TH2221SS	\$1218.00
60A	NEMA Type 4/4X	3	7 1/2	10	15	5	10	TH2222SS	\$1463.00
100A	NEMA Type 4/4X	7 1/2	15	15	30	-	20	TH3223SS	\$3309.00
200A	NEMA Type 4/4X	15	25	-	60	-	40	TH3224SS	\$4538.00
400A	NEMA Type 4/4X	-	50	-	125	-	50	TH3225SS	\$9114.00
600A	NEMA Type 4/4X	-	75	-	200	-	50	TH3226SS	\$13008.00
30A	NEMA Type 5, 12	1 1/2	3	3	7 1/2	-	5	TH2221J	\$295.00
60A	NEMA Type 5, 12	3	7 1/2	10	15	5	10	TH2222J	\$398.00
100A	NEMA Type 5, 12	7 1/2	15	15	30	-	20	TH3223J	\$678.00
200A	NEMA Type 5, 12	15	25	-	60	-	40	TH3224J	\$1058.00
400A	NEMA Type 5, 12	-	50	-	125	-	50	TH3225J	\$2623.00
600A	NEMA Type 5, 12	-	75	-	200	-	50	TH3226J	\$4281.00

Fusible, Three-wire SN, 120/240 and 240 Volts ac									GO-131
Ampere Rating	Enclosure Type	HP, 240 Vac, NEC Std, 1-ph	HP, 240 Vac, NEC Std, 3-ph	HP, 240 Vac, Time Delay, 1-ph	HP, 240 Vac, Time Delay, 3-ph	HP, 125 Vdc	HP, 250 Vdc	Product Number	List Price
30A	NEMA Type 1	1 1/2	3	3	7 1/2	-	5	TH3221	\$153.00
60A	NEMA Type 1	3	7 1/2	10	15	5	10	TH3222	\$300.00
100A	NEMA Type 1	7 1/2	15	15	30	-	20	TH3223	\$467.00
200A	NEMA Type 1	15	25	-	60	-	40	TH3224	\$830.00
400A	NEMA Type 1	-	50	-	125	-	50	TH3225	\$1948.00
600A	NEMA Type 1	-	75	-	200	-	50	TH3226	\$3670.00
800A	NEMA Type 1	-	-	-	-	-	-	TC72267 <sup>1,3</sup>	\$6996.00
1200A	NEMA Type 1	-	-	-	-	-	-	TNI67	\$490.00
								TC72268 <sup>1,3</sup>	\$9614.00
								TNI68A	\$675.00
30A	NEMA Type 3R	1 1/2	3	3	7 1/2	-	5	TH3221R	\$291.00
60A	NEMA Type 3R	3	7 1/2	10	15	5	10	TH3222R	\$542.00
100A	NEMA Type 3R	7 1/2	15	15	30	-	20	TH3223R	\$702.00
200A	NEMA Type 3R	15	25	-	60	-	40	TH3224R	\$1006.00
400A	NEMA Type 3R	-	50	-	125	-	50	TH3225R	\$2450.00
600A	NEMA Type 3R	-	75	-	200	-	50	TH3226R	\$4590.00
800A	NEMA Type 3R	-	-	-	-	-	-	TC72267R <sup>2,3</sup>	\$8975.00
								TNI67	\$490.00
1200A	NEMA Type 3R	-	-	-	-	-	-	TC72268R <sup>2,3</sup>	\$13127.00
								TNI68A	\$675.00
30A	NEMA Type 4/4X	1 1/2	3	3	7 1/2	-	5	TH3221SS	\$1260.00
60A	NEMA Type 4/4X	3	7 1/2	10	15	5	10	TH3222SS	\$1526.00
100A	NEMA Type 4/4X	7 1/2	15	15	30	-	20	TH3223SS	\$3309.00
200A	NEMA Type 4/4X	15	25	-	60	-	40	TH3224SS	\$4538.00
400A	NEMA Type 4/4X	-	50	-	125	-	50	TH3225SS	\$9114.00
600A	NEMA Type 4/4X	-	75	-	200	-	50	TH3226SS	\$13008.00
30A	NEMA Type 5, 12	1 1/2	3	3	7 1/2	-	5	TH3221J	\$345.00
60A	NEMA Type 5, 12	3	7 1/2	10	15	5	10	TH3222J	\$462.00
100A	NEMA Type 5, 12	7 1/2	15	15	30	-	20	TH3223J	\$678.00
200A	NEMA Type 5, 12	15	25	-	60	-	40	TH3224J	\$1058.00
400A	NEMA Type 5, 12	-	50	-	125	-	50	TH3225J	\$2623.00
600A	NEMA Type 5, 12	-	75	-	200	-	50	TH3226J	\$4281.00

<sup>1</sup>Class L fuses are only applicable when used with 800 and 1200A Type TC Safety Switches (e.g. TC72367).

<sup>2</sup>Not CSA certified.

<sup>3</sup>Order switch and neutral separately.

**Publications and Reference:** See Section 21 for a list of additional product-related publications





## Heavy Duty, Type TH

Spec-Setter Safety Switches

30-1200 Amperes

240 Volts AC

250 Volts DC

### Fusible, Three-pole, 240 Volts ac

GO-131

Ampere Rating	Enclosure Type	HP, 240 Vac, NEC Std, 1-ph	HP, 240 Vac, NEC Std, 3-ph	HP, 240 Vac, Time Delay, 1-ph	HP, 240 Vac, Time Delay, 3-ph	HP, 125 Vdc	HP, 250 Vdc	Product Number	List Price
30A	NEMA Type 1	1 1/2	3	3	7 1/2	-	5	TH4321	\$203.00
60A	NEMA Type 1	3	7 1/2	10	15	5	10	TH4322	\$344.00
100A	NEMA Type 1	7 1/2	15	15	30	-	20	TH4323	\$542.00
200A	NEMA Type 1	15	25	-	60	-	40	TH4324	\$932.00
400A	NEMA Type 1	-	50	-	125	-	50	TH3325	\$2157.00
600A	NEMA Type 1	-	75	-	200	-	50	TH3326	\$3889.00
800A	NEMA Type 1	-	-	-	-	-	-	TC72367 <sup>1,3</sup>	\$9661.00
1200A	NEMA Type 1	-	-	-	-	-	-	TC72368 <sup>1,3</sup>	\$12688.00
30A	NEMA Type 3R	1 1/2	3	3	7 1/2	-	5	TH4321R	\$364.00
60A	NEMA Type 3R	3	7 1/2	10	15	5	10	TH4322R	\$573.00
100A	NEMA Type 3R	7 1/2	15	15	30	-	20	TH4323R	\$821.00
200A	NEMA Type 3R	15	25	-	60	-	40	TH4324R	\$1130.00
400A	NEMA Type 3R	-	50	-	125	-	50	TH3325R	\$2501.00
600A	NEMA Type 3R	-	75	-	200	-	50	TH3326R	\$5235.00
800A	NEMA Type 3R	-	-	-	-	-	-	TC72367R <sup>2,3</sup>	\$11966.00
1200A	NEMA Type 3R	-	-	-	-	-	-	TC72368R <sup>2,3</sup>	\$15546.00
30A	NEMA Type 4/4X	1 1/2	3	3	7 1/2	-	5	TH3321SS	\$1294.00
60A	NEMA Type 4/4X	3	7 1/2	10	15	5	10	TH3322SS	\$1597.00
100A	NEMA Type 4/4X	7 1/2	15	15	30	-	20	TH4323SS	\$3380.00
200A	NEMA Type 4/4X	15	25	-	60	-	40	TH4324SS	\$4733.00
400A	NEMA Type 4/4X	-	50	-	125	-	50	TH4325SS	\$9542.00
600A	NEMA Type 4/4X	-	75	-	200	-	50	TH4326SS	\$13570.00
30A	NEMA Type 5, 12	1 1/2	3	3	7 1/2	-	5	TH3321J	\$391.00
60A	NEMA Type 5, 12	3	7 1/2	10	15	5	10	TH3322J	\$551.00
100A	NEMA Type 5, 12	7 1/2	15	15	30	-	20	TH4323J	\$881.00
200A	NEMA Type 5, 12	15	25	-	60	-	40	TH4324J	\$1262.00
400A	NEMA Type 5, 12	-	50	-	125	-	50	TH4325J	\$2896.00
600A	NEMA Type 5, 12	-	75	-	200	-	50	TH4326J	\$4657.00

### Fusible, Four-wire SN, 208/120 and 240 Volts ac

GO-131

Ampere Rating	Enclosure Type	HP, 240 Vac, NEC Std, 1-ph	HP, 240 Vac, NEC Std, 3-ph	HP, 240 Vac, Time Delay, 1-ph	HP, 240 Vac, Time Delay, 3-ph	HP, 125 Vdc	HP, 250 Vdc	Product Number	List Price
30A	NEMA Type 1	1 1/2	3	3	7 1/2	-	5	TH4321	\$203.00
60A	NEMA Type 1	3	7 1/2	10	15	5	10	TH4322	\$344.00
100A	NEMA Type 1	7 1/2	15	15	30	-	20	TH4323	\$542.00
200A	NEMA Type 1	15	25	-	60	-	40	TH4324	\$932.00
400A	NEMA Type 1	-	50	-	125	-	50	TH4325	\$2391.00
600A	NEMA Type 1	-	75	-	200	-	50	TH4326	\$4116.00
800A	NEMA Type 1	-	-	-	-	-	-	TC72367 <sup>1,3</sup>	\$9661.00
1200A	NEMA Type 1	-	-	-	-	-	-	TNI67	\$490.00
								TC72368 <sup>1,3</sup>	\$12688.00
								TNI68A	\$675.00
30A	NEMA Type 3R	1 1/2	3	3	7 1/2	-	5	TH4321R	\$364.00
60A	NEMA Type 3R	3	7 1/2	10	15	5	10	TH4322R	\$573.00
100A	NEMA Type 3R	7 1/2	15	15	30	-	20	TH4323R	\$821.00
200A	NEMA Type 3R	15	25	-	60	-	40	TH4324R	\$1130.00
400A	NEMA Type 3R	-	50	-	125	-	50	TH3325R	\$2501.00
600A	NEMA Type 3R	-	75	-	200	-	50	TH3326R	\$5235.00
800A	NEMA Type 3R	-	-	-	-	-	-	TC72367R <sup>2,3</sup>	\$11966.00
								TNI67	\$490.00
1200A	NEMA Type 3R	-	-	-	-	-	-	TC72368R <sup>2,3</sup>	\$15546.00
								TNI68A	\$675.00
30A	NEMA Type 4/4X	1 1/2	3	3	7 1/2	-	5	TH4321SS	\$1355.00
60A	NEMA Type 4/4X	3	7 1/2	10	15	5	10	TH4322SS	\$1654.00
100A	NEMA Type 4/4X	7 1/2	15	15	30	-	20	TH4323SS	\$3380.00
200A	NEMA Type 4/4X	15	25	-	60	-	40	TH4324SS	\$4733.00
400A	NEMA Type 4/4X	-	50	-	125	-	50	TH4325SS	\$9542.00
600A	NEMA Type 4/4X	-	75	-	200	-	50	TH4326SS	\$13570.00
30A	NEMA Type 5, 12	1 1/2	3	3	7 1/2	-	5	TH4321J	\$445.00
60A	NEMA Type 5, 12	3	7 1/2	10	15	5	10	TH4322J	\$599.00
100A	NEMA Type 5, 12	7 1/2	15	15	30	-	20	TH4323J	\$881.00
200A	NEMA Type 5, 12	15	25	-	60	-	40	TH4324J	\$1262.00
400A	NEMA Type 5, 12	-	50	-	125	-	50	TH4325J	\$2896.00
600A	NEMA Type 5, 12	-	75	-	200	-	50	TH4326J	\$4657.00

240 Volts - No fuse or Four-pole, 240 Volts ac, Use 600-Volt switches on page 2-10 through 2-13.

For Type 1 Enclosure: 200-600 amp devices available factory reversed for bottom feed. Add "B" suffix to product number (e.g., TH3224B) List Price Adder \$44.00, Go-131A. UL Listed.

For Type 3R Enclosure: 30-200 amp devices have removable closing cap. Order hubs for these devices separately on page 2-30. Larger amp devices require field cut openings and customer-supplied hub.

<sup>1</sup>Class L fuses are only applicable when used with 800 and 1200A Type TC Safety Switches (e.g. TC72367).

<sup>2</sup>Not CSA certified.

<sup>3</sup>Order switch and neutral separately



Accessories and Lug Sizes: See pages 2-25 to 2-30

Outlines, Dimensions and Knockouts: See pages 2-31 to 2-39



**Heavy Duty, Type TH**

*Spec-Setter Safety Switches*

*30-1200 Amperes*

*240, 480, 600 Volts AC*

*600 Volts DC*

**Reference Publications**

Descriptive Bulletin	GEA-12144
Replacement Parts Bulletin	GEF-4452



*Two-pole, 600 Volts dc, Fusible*

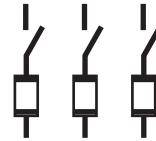

*Three-pole, 480, 480Y/277 and 600 Volts ac-250 Volts dc, Fusible*

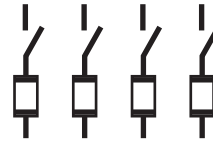

*Four-pole, 480 and 600 Volts ac, Fusible*



*Two-pole, 600 Volts dc, No Fuse*

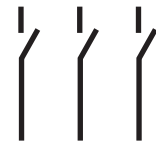

*Three-pole, 480 and 600 Volts ac-250 Volts DC or Two-pole with Switching Neutral, No Fuse*



*Four-pole, 480 and 600 Volts dc, No Fuse*

**Publications and Reference:** See Section 21 for a list of additional product-related publications



## Heavy Duty, Type TH

Spec-Setter Safety Switches

30-1200 Amperes

240, 480, 600 Volts AC

600 Volts DC

SAFETY SWITCHES

2

### Two-pole 600 Volts dc, Fusible

GO-131

Ampere Rating	Enclosure Type	HP, 480 Vac, NEC Std, 3-ph	HP, 600 Vac, NEC Std, 3-ph	HP, 480 Vac, Time Delay, 3-ph	HP, 600 Vac, Time Delay, 3-ph	HP, 125 Vdc	HP, 250 Vdc	HP, 600 Vdc	Product Number	List Price
30A	NEMA Type 1	-	-	-	-	-	-	15	TH2261DC	\$344.00
60A	NEMA Type 1	-	-	-	-	-	-	25	TH2262DC	\$417.00
100A	NEMA Type 1	-	-	-	-	-	-	25	TH2263DC	\$763.00
30A	NEMA Type 3R	-	-	-	-	-	-	15	TH2261RDC	\$579.00
60A	NEMA Type 3R	-	-	-	-	-	-	25	TH2262RDC	\$678.00
100A	NEMA Type 3R	-	-	-	-	-	-	25	TH2263RDC	\$1058.00
30A	NEMA Type 4/4X	-	-	-	-	-	-	15	TH2261SSDC	\$1578.00
60A	NEMA Type 4/4X	-	-	-	-	-	-	25	TH2262SSDC	\$1639.00
100A	NEMA Type 4/4X	-	-	-	-	-	-	25	TH2263SSDC	\$3473.00
30A	NEMA Type 5, 12	-	-	-	-	-	-	15	TH2261JDC	\$538.00
60A	NEMA Type 5, 12	-	-	-	-	-	-	25	TH2262JDC	\$563.00
100A	NEMA Type 5, 12	-	-	-	-	-	-	25	TH2263JDC	\$930.00

For Type 1 Enclosure: 200-600 amp devices available factory reversed for bottom feed. Add "B" suffix to product number (e.g., TH33365B). List Price adder \$44.00, GO-131. UL Listed.

For Type 3R Enclosure: 30-200 amp devices have removable closing cap. Order hubs for these devices separately on page 2-30. Larger amp devices require field cut openings and customer-supplied hub.



Accessories and Lug Sizes: See pages 2-25 to 2-30  
 Outlines, Dimensions and Knockouts: See pages 2-31 to 2-39

**Heavy Duty, Type TH**  
**Spec-Setter Safety Switches**  
 30-1200 Amperes  
 240, 480, 600 Volts AC  
 600 Volts DC



TH3361RF

**Three-pole, 480, 480Y/277<sup>1</sup> and 600 Volts ac-250 dc, Fusible** GO-131

Ampere Rating	Enclosure Type	HP, 480 Vac, NEC Std, 3-ph	HP, 600 Vac, NEC Std, 3-ph	HP, 480 Vac, Time Delay, 3-ph	HP, 600 Vac, Time Delay, 3-ph	HP, 125 Vdc	HP, 250 Vdc	HP, 600 Vdc	Product Number	List Price
30A	NEMA Type 1	5	7 1/2	15	20	-	5	-	TH3361	\$344.00
60A	NEMA Type 1	15	15	30	50	-	10	-	TH3362	\$417.00
100A	NEMA Type 1	25	30	60	75	-	20	-	TH3363	\$763.00
200A	NEMA Type 1	50	60	125	150	-	40	-	TH3364	\$1103.00
400A	NEMA Type 1	100	125	250	350	-	50	-	TH3365	\$2868.00
600A	NEMA Type 1	150	200	400	500	-	50	-	TH3366	\$4825.00
800A	NEMA Type 1	-	-	-	-	-	-	-	TC72367 <sup>2</sup>	\$9661.00
1200A	NEMA Type 1	-	-	-	-	-	-	-	TC72368 <sup>2</sup>	\$12688.00
30A	NEMA Type 3R	5	7 1/2	15	20	-	5	-	TH3361R	\$579.00
30A	NEMA Type 3R	5	7 1/2	15	20	-	5	-	TH3361RF <sup>4</sup>	\$579.00
60A	NEMA Type 3R	15	15	30	50	-	10	-	TH3361RF <sup>4</sup>	\$749.00
60A	NEMA Type 3R	15	15	30	50	-	10	-	TH3362R	\$678.00
60A	NEMA Type 3R	15	15	30	50	-	10	-	TH3362RF <sup>4</sup>	\$678.00
100A	NEMA Type 3R	25	30	60	75	-	20	-	TH3363R	\$1058.00
200A	NEMA Type 3R	50	60	125	150	-	40	-	TH3364R	\$1461.00
400A	NEMA Type 3R	100	125	250	350	-	50	-	TH3365R	\$3414.00
600A	NEMA Type 3R	150	200	400	500	-	50	-	TH3366R	\$6738.00
800A	NEMA Type 3R	-	-	-	-	-	-	-	TC72367R <sup>2,3</sup>	\$11966.00
1200A	NEMA Type 3R	-	-	-	-	-	-	-	TC72368R <sup>2,3</sup>	\$15546.00
30A	NEMA Type 4/4X	5	7 1/2	15	20	-	5	-	TH3361SS	\$1577.00
60A	NEMA Type 4/4X	15	15	30	50	-	10	-	TH3362SS	\$1737.00
100A	NEMA Type 4/4X	25	30	60	75	-	20	-	TH3363SS	\$3461.00
200A	NEMA Type 4/4X	50	60	125	150	-	40	-	TH3364SS	\$4849.00
400A	NEMA Type 4/4X	100	125	250	350	-	50	-	TH3365SS	\$9542.00
600A	NEMA Type 4/4X	150	200	400	500	-	50	-	TH3366SS	\$13570.00
30A	NEMA Type 5, 12	5	7 1/2	15	20	-	5	-	TH3361J	\$586.00
60A	NEMA Type 5, 12	15	15	30	50	-	10	-	TH3362J	\$602.00
100A	NEMA Type 5, 12	25	30	60	75	-	20	-	TH3363J	\$967.00
200A	NEMA Type 5, 12	50	60	125	150	-	40	-	TH3364J	\$1505.00
400A	NEMA Type 5, 12	100	125	250	350	-	50	-	TH3365J	\$3311.00
600A	NEMA Type 5, 12	150	200	400	500	-	50	-	TH3366J	\$5582.00
30A	NEMA Type 3R, 5, 12	5	7 1/2	15	20	-	5	-	TH3361JR	\$579.00
60A	NEMA Type 3R, 5, 12	15	15	30	50	-	10	-	TH3362JR	\$678.00
100A	NEMA Type 3R, 5, 12	25	30	60	75	-	20	-	TH3363JR	\$1058.00
200A	NEMA Type 3R, 5, 12	50	60	125	150	-	40	-	TH3364JR	\$1461.00
400A	NEMA Type 3R, 5, 12	100	125	250	350	-	50	-	TH3365JR	\$3414.00
600A	NEMA Type 3R, 5, 12	150	200	400	500	-	50	-	TH3366JR	\$6738.00

**Four-pole, 480 and 600 Volts ac, Fusible<sup>5</sup>** GO-131

Ampere Rating	Enclosure Type	HP, 480 Vac, NEC Std, 2-ph	HP, 600 Vac, NEC Std, 2-ph	HP, 480 Vac, Time Delay, 2-ph	HP, 600 Vac, Time Delay, 2-ph	HP, 125 Vdc	HP, 250 Vdc	HP, 600 Vdc	Product Number	List Price
30A	NEMA Type 1, 3R, 5, 12	7 1/2	10	20	25	-	5	-	TH6661	\$2303.00
60A	NEMA Type 1, 3R, 5, 12	15	20	40	50	-	10	-	TH6662	\$2762.00
100A	NEMA Type 1, 3R, 5, 12	20	30	50	50	-	20	-	TH6663	\$3358.00
200A	NEMA Type 1, 3R, 5, 12	50	50	-	-	-	40	-	TH6664	\$7555.00

For Type 1 Enclosure: 200-600 amp devices available factory reversed for bottom feed. Add "B" suffix to product number (e.g., TH33365B). List Price adder \$44.00, GO-131. UL Listed.  
 For Type 3R Enclosure: 30-200 amp devices have removable closing cap. Order hubs for these devices separately on page 2-30. Larger amp devices require field cut openings and customer-supplied hub.

<sup>1</sup>Order neutral kits from pages 2-25 and 2-27.

<sup>2</sup>Type TH electrical performance does not apply to Type TC switches. Class "L" fuses are ac only.

<sup>3</sup>Not CSA Certified

<sup>4</sup>RF-version provides for vertically-hinged NEMA 3R door. RF2-version is a 30A switch interior in a larger 60A enclosure with vertically-hinged door.

<sup>5</sup>Use four poles of six-pole

**Publications and Reference:** See Section 21 for a list of additional product-related publications



## Heavy Duty, Type TH

Spec-Setter Safety Switches

30-1200 Amperes

240, 480, 600 Volts AC

600 Volts DC

### Two-pole, 600 Volts dc, No Fuse

GO-131

Ampere Rating	Enclosure Type	HP, 240 Vac, NEC Std, 1-ph	HP, 240 Vac, NEC Std, 3-ph	HP, 480 Vac, Time Delay, 3-ph	HP, 600 Vac, Time Delay, 3-ph	HP, 125 Vdc	HP, 250 Vdc	HP, 600 Vdc	Product Number	List Price
30A	NEMA Type 1	-	-	-	-	-	-	15	THN2261DC	\$179.00
60A	NEMA Type 1	-	-	-	-	-	-	25	THN2262DC	\$324.00
100A	NEMA Type 1	-	-	-	-	-	-	25	THN2263DC	\$510.00
30A	NEMA Type 3R	-	-	-	-	-	-	15	THN2261RDC	\$322.00
60A	NEMA Type 3R	-	-	-	-	-	-	25	THN2262RDC	\$564.00
100A	NEMA Type 3R	-	-	-	-	-	-	25	THN2263RDC	\$788.00
30A	NEMA Type 4/4X	-	-	-	-	-	-	15	THN2261SSDC	\$1300.00
60A	NEMA Type 4/4X	-	-	-	-	-	-	25	THN2262SSDC	\$1562.00
100A	NEMA Type 4/4X	-	-	-	-	-	-	25	THN2263SSDC	\$3216.00
30A	NEMA Type 5, 12	-	-	-	-	-	-	15	THN2261JDC	\$352.00
60A	NEMA Type 5, 12	-	-	-	-	-	-	25	THN2262JDC	\$397.00
100A	NEMA Type 5, 12	-	-	-	-	-	-	25	THN2263JDC	\$632.00

### Three-pole, 480 and 600 Volts ac - 250 Volts dc or Two-pole with Switching Neutral, No Fuse

GO-131

Ampere Rating	Enclosure Type	HP, 240 Vac, NEC Std, 1-ph	HP, 240 Vac, NEC Std, 3-ph	HP, 480 Vac, Time Delay, 3-ph	HP, 600 Vac, Time Delay, 3-ph	HP, 125 Vdc	HP, 250 Vdc	HP, 600 Vdc	Product Number	List Price
30A	NEMA Type 1	3	10	-	-	3	5	-	THN3321 <sup>1</sup>	\$171.00
30A	NEMA Type 1	3	10	20	30	3	5	-	THN3361	\$179.00
60A	NEMA Type 1	10	20	50	60	5	10	-	THN3362	\$324.00
100A	NEMA Type 1	20	40	75	100	-	20	-	THN3363	\$510.00
200A	NEMA Type 1	30	60	125	150	-	40	-	THN3364	\$775.00
400A	NEMA Type 1	-	125	250	350	-	50	-	THN3365	\$1736.00
600A	NEMA Type 1	-	200	400	500	-	50	-	THN3366	\$3092.00
800A	NEMA Type 1	-	-	-	-	-	-	-	TC36367 <sup>2,3</sup>	\$6302.00
1200A	NEMA Type 1	-	-	-	-	-	-	-	TC36368 <sup>2,3</sup>	\$8457.00
30A	NEMA Type 3R	3	10	20	30	3	5	-	THN3361R	\$322.00
30A	NEMA Type 3R	3	10	20	30	3	5	-	THN3361RF <sup>4</sup>	\$436.00
60A	NEMA Type 3R	10	20	50	60	5	10	-	THN3362R	\$564.00
60A	NEMA Type 3R	10	20	50	60	5	10	-	THN3362RF <sup>4</sup>	\$564.00
100A	NEMA Type 3R	20	40	75	100	-	20	-	THN3363R	\$788.00
200A	NEMA Type 3R	30	60	125	150	-	40	-	THN3364R	\$957.00
400A	NEMA Type 3R	-	125	250	350	-	50	-	THN3365R	\$2376.00
600A	NEMA Type 3R	-	200	400	500	-	50	-	THN3366R	\$4755.00
30A	NEMA Type 4/4X	3	10	20	30	3	5	-	THN3361SS	\$1326.00
60A	NEMA Type 4/4X	10	20	50	60	5	10	-	THN3362SS	\$1577.00
100A	NEMA Type 4/4X	20	40	75	100	-	20	-	THN3363SS	\$3217.00
200A	NEMA Type 4/4X	30	60	125	150	-	40	-	THN3364SS	\$4393.00
400A	NEMA Type 4/4X	-	125	250	350	-	50	-	THN3365SS	\$8899.00
600A	NEMA Type 4/4X	-	200	400	500	-	50	-	THN3366SS	\$11946.00
30A	NEMA Type 5, 12	3	10	20	30	3	5	-	THN3361J	\$412.00
60A	NEMA Type 5, 12	10	20	50	60	5	10	-	THN3362J	\$533.00
100A	NEMA Type 5, 12	20	40	75	100	-	20	-	THN3363J	\$758.00
200A	NEMA Type 5, 12	30	60	125	150	-	40	-	THN3364J	\$1008.00
400A	NEMA Type 5, 12	-	125	250	350	-	50	-	THN3365J	\$2497.00
600A	NEMA Type 5, 12	-	200	400	500	-	50	-	THN3366J	\$4065.00

For Type 1 Enclosure: 200-600 amp devices available factory reversed for bottom feed. Add "B" suffix to product number (e.g., TH33365B). List Price adder \$44.00, GO-131. UL Listed.  
For Type 3R Enclosure: 30-200 amp devices have removable closing cap. Order hubs for these devices separately on page 2-30. Larger amp devices require field cut openings and customer-supplied hub.

Use molded case switch in circuit breaker enclosure.

<sup>1</sup>250 volts ac or 250 volts dc only. Compact enclosure.

<sup>2</sup>Class "L" fuses are only applicable when used with 800 and 1200A Type TC Safety Switches (e.g. TC72367).

<sup>3</sup>Not available with neutral.

<sup>4</sup>RF-version provides for vertically-hinged NEMA 3R door.



Accessories and Lug Sizes: See pages 2-25 to 2-30  
Outlines, Dimensions and Knockouts: See pages 2-31 to 2-39

**Heavy Duty, Type TH**  
**Spec-Setter Safety Switches**  
**30-1200 Amperes**  
**240, 480, 600 Volts AC**  
**600 Volts DC**

**Four-pole, 480 and 600 Volts ac, No Fuse<sup>2,3</sup> GO-131**

Ampere Rating	Enclosure Type	HP, 240 Vac, NEC Std, 1-ph	HP, 240 Vac, NEC Std, 2-ph	HP, 480 Vac, Time Delay, 2-ph	HP, 600 Vac, Time Delay, 2-ph	HP, 125 Vdc	HP, 250 Vdc	HP, 600 Vdc	Product Number	List Price
30A	NEMA Type 1, 3R, 5, 12	-	10	20	25	-	5	-	THN6661	\$2048.00
60A	NEMA Type 1, 3R, 5, 12	-	20	40	50	-	10	-	THN6662	\$2372.00
100A	NEMA Type 1, 3R, 5, 12	-	30	50	50	-	20	-	THN6663	\$2919.00
200A	NEMA Type 1, 3R, 5, 12	-	50	-	-	-	40	-	THN6664	\$6564.00

**Heavy Duty Safety Switches with 317 Stainless Steel Type NEMA 4/4X, Water and Dust-tight**

- More resistant to general corrosion and pitting/crevice corrosion than 304 stainless steel
- Higher creep, stress-to-rupture and tensile strength at elevated temperatures than 304 stainless steel
- Excellent resistance to reducing acids and similar media
- Standard lead time 2 weeks

**Three-pole 240/600 Volts—Fusible, 317 Stainless Steel GO-131**

Ampere Rating	Enclosure Type	System Voltage	Product Number	List Price
30A	NEMA Type 4/4X	600Vdc	TH2261SSDC3 <sup>1</sup>	\$2191.00
30A	NEMA Type 4/4X	240Vac	TH3221SS317	\$1836.00
30A	NEMA Type 4/4X	600Vac	TH3361SS317	\$2296.00
60A	NEMA Type 4/4X	600Vac	TH3362SS317	\$2528.00
100A	NEMA Type 4/4X	600Vac	TH3363SS317	\$5041.00
200A	NEMA Type 4/4X	600Vac	TH3364SS317	\$7061.00

**Three-pole 600 Volts—Non-Fusible, 317 Stainless Steel GO-131**

Ampere Rating	Enclosure Type	System Voltage	Product Number	List Price
30A	NEMA Type 4/4X	600Vac	THN3361SS317	\$1932.00
60A	NEMA Type 4/4X	600Vac	THN3362SS317	\$2296.00
100A	NEMA Type 4/4X	600Vac	THN3363SS317	\$4686.00
200A	NEMA Type 4/4X	600Vac	THN3364SS317	\$6167.00
400A	NEMA Type 4/4X	600Vac	THN3365SS317	\$12458.00
600A	NEMA Type 4/4X	600Vac	THN3366SS317	\$17231.00

**Viewing Window Option—Factory Installed Only**

**UL Listed Installation-Safety Switch Rating NEMA Type 4/4X, 5, 12 Standard Lead Time-3 Weeks**

Factory Installed Product Number	Suffix for Water and Dust Tight NEMA Type 4/4X	List Price, GO-131	Suffix for Drip and Dust Tight NEMA Type 5, 12	List Price, GO-131
TH2221	SSW	\$1260.00	JW	\$370.00
TH2222	SSW	\$1499.00	JW	\$469.00
TH3221	SSW	\$1302.00	JW	\$396.00
TH3222	SSW	\$1429.00	JW	\$499.00
TH3223	SSW	\$3291.00	JW	\$756.00
TH3224	SSW	\$4482.00	JW	\$1137.00
TH3321	SSW	\$1322.00	JW	\$440.00
TH3322	SSW	\$1615.00	JW	\$590.00
TH3361	SSW	\$1610.00	JW	\$642.00
TH3362	SSW	\$1764.00	JW	\$657.00
TH3363	SSW	\$3439.00	JW	\$972.00
TH3364	SSW	\$4785.00	JW	\$1512.00
TH4321	SSW	\$1381.00	JW	\$483.00
TH4322	SSW	\$1668.00	JW	\$622.00
TH4323	SSW	\$3457.00	JW	\$958.00
TH4324	SSW	\$4811.00	JW	\$1341.00
THN3361	SSW	\$1366.00	JW	\$473.00
THN3362	SSW	\$1610.00	JW	\$564.00
THN3363	SSW	\$3200.00	JW	\$780.00
THN3364	SSW	\$5158.00	JW	\$1011.00

<sup>1</sup>2-pole device

<sup>2</sup>Not CSA Certified

<sup>3</sup>Use four poles of six-pole switch. Reference page 2-20 for additional information.

**Publications and Reference:** See Section 21 for a list of additional product-related publications



## Mill Duty, Type TH

Spec-Setter Safety Switches

30-600 Amperes

240, 480, 600 Volts AC

250, 600 Volts DC

### Cartridge Fuse, Type TH Switches

- Designed for mill, foundry and industrial applications where safety, high performance and continuity of service are required.
- UL Listed. Products in this section have been tested by UL and shown to meet the construction and performance requirements of UL Standard Number 98, Enclosed and Dead Front Switches.
- Meet Federal Specification WS-865C for heavy duty switches.
- Meet major automotive manufacturer's and JIC electrical specifications.
- Meet NEMA Enclosed Safety Switch Standard KS1-1990 for Type HD.
- Full cover interlocks.
- 60°C and 75°C conductor ratings.
- Quick-make, quick-break mechanisms.
- Suitable for use as service entrance equipment when installed in accordance with the National Electrical Code.
- UL Listed ratings for fusible switches when used with these fuses:
  - Class H (10,000 rms amps, sym IC). Standard on 30-600 amp.
  - Class J (200,000 rms amp, sym IC). See page 2-29 for field conversion details.
  - Class R (200,000 rms amp, sym IC). Order appropriate Class R fusing kit from page 2-29.
- Safety switch product numbers with suffix "SS" are grade 304 stainless steel. Product numbers with "SS317" are grade 317 stainless steel.

### Type TH Interrupting and Withstandability Ratings

Ampere Rating	Interrupting Rating Amps	
	Symmetrical 600 volts AC, 3-phase	Fuse Clearing
30A	360	50
60A	1200	200
100A	1200	500
200A	3,400	2,000
400A	10,000	6,000
600A	10,000	12,000

### Reference Publications

Descriptive Bulletin	GEA-12144
Replacement Parts Bulletin	GEF-4452



Two-pole, 240 Volts ac - 250 Volts dc, Fusible

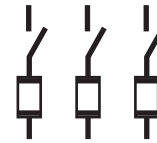

Three-pole, 240 Volts ac, Fusible



Two-pole, 600 Volts dc, Fusible

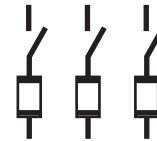

Three-pole, 480 and 600 Volts ac - 250 Volts dc Fusible



Two-pole, 600 Volts dc, No Fuse

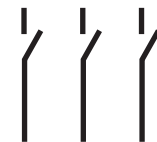

Three-pole, 480 and 600 Volts ac - 250 Volts dc, No Fuse

Accessories and Lug Sizes: See pages 2-25 to 2-30  
 Outlines, Dimensions and Knockouts: See pages 2-31 to 2-39



**Mill Duty, Type TH**  
**Spec-Setter Safety Switches**  
**300-600 Amperes**  
**240, 480, 600 Volts AC**  
**250, 600 Volts DC**

**Two-pole, 240 Volts ac - 250 Volts dc, Fusible** **GO-131B**

Ampere Rating	Enclosure Type <sup>1</sup>	HP, 240 Vac, NEC Std, 1-ph	HP, 240 Vac, NEC Std, 3-ph	HP, 240 Vac, Time Delay, 1-ph	HP, 240 Vac, Time Delay, 3-ph	HP, 125 Vdc	HP, 250 Vdc	HP, 600 Vdc	Product Number	List Price
30A	NEMA Type 12	1 1/2	-	3	-	-	5	-	TH2221M	\$324.00
60A	NEMA Type 12	3	-	10	-	5	10	-	TH2222M	\$437.00
100A	NEMA Type 12	7 1/2	-	15	-	-	20	-	TH2223M	\$647.00
200A	NEMA Type 12	15	-	-	-	-	40	-	TH2224M	\$1085.00
30A	NEMA Type 4/4X	1 1/2	-	3	-	-	5	-	TH2221MSS	\$1349.00
60A	NEMA Type 4/4X	3	-	10	-	5	10	-	TH2222MSS	\$1630.00
100A	NEMA Type 4/4X	7 1/2	-	15	-	-	20	-	TH2223MSS	\$3573.00
200A	NEMA Type 4/4X	15	-	-	-	-	40	-	TH2224MSS	\$4914.00

**Three-pole, 240 Volts ac, Fusible** **GO-131B**

Ampere Rating	Enclosure Type <sup>1</sup>	HP, 240 Vac, NEC Std, 1-ph	HP, 240 Vac, NEC Std, 3-ph	HP, 240 Vac, Time Delay, 1-ph	HP, 240 Vac, Time Delay, 3-ph	HP, 125 Vdc	HP, 250 Vdc	HP, 600 Vdc	Product Number	List Price
30A	NEMA Type 12	1 1/2	3	3	7 1/2	-	5	-	TH3321M	\$393.00
60A	NEMA Type 12	3	7 1/2	10	15	5	10	-	TH3322M	\$566.00
100A	NEMA Type 12	7 1/2	15	15	30	-	20	-	TH3323M	\$875.00
200A	NEMA Type 12	15	25	-	60	-	40	-	TH3324M	\$1305.00
400A	NEMA Type 12	-	50	-	125	-	50	-	TH3325M	\$2883.00
600A	NEMA Type 12	-	75	-	200	-	50	-	TH3326M	\$4804.00
30A	NEMA Type 4/4X	1 1/2	3	3	7 1/2	-	5	-	TH3321MSS	\$1432.00
60A	NEMA Type 4/4X	3	7 1/2	10	15	5	10	-	TH3322MSS	\$1767.00
100A	NEMA Type 4/4X	7 1/2	15	15	30	-	20	-	TH3323MSS	\$3771.00
200A	NEMA Type 4/4X	15	25	-	60	-	40	-	TH3324MSS	\$5305.00
400A	NEMA Type 4/4X	-	50	-	125	-	50	-	TH3325MSS	\$10039.00
600A	NEMA Type 4/4X	-	75	-	200	-	50	-	TH3326MSS	\$14480.00

240 Volts-No Fuse use 600 Volt switches

**Two-pole, 600 Volts dc, Fusible** **GO-131B**

Ampere Rating	Enclosure Type <sup>1</sup>	HP, 480 Vac, NEC Std, 3-ph	HP, 600 Vac, NEC Std, 3-ph	HP, 480 Vac, Time Delay, 3-ph	HP, 600 Vac, Time Delay, 3-ph	HP, 125 Vdc	HP, 250 Vdc	HP, 600 Vdc	Product Number	List Price
30A	NEMA Type 12	-	-	-	-	-	-	15	TH2261MDC	\$579.00
60A	NEMA Type 12	-	-	-	-	-	-	25	TH2262MDC	\$600.00
100A	NEMA Type 12	-	-	-	-	-	-	25	TH2263MDC	\$929.00
30A	NEMA Type 4/4X	-	-	-	-	-	-	15	TH2261MSSDC	\$1760.00
60A	NEMA Type 4/4X	-	-	-	-	-	-	25	TH2262MSSDC	\$1943.00
100A	NEMA Type 4/4X	-	-	-	-	-	-	25	TH2263MSSDC	\$3864.00

**Three-pole, 480 and 600 Volts ac - 250 Volts dc, Fusible** **GO-131B**

Ampere Rating	Enclosure Type <sup>1</sup>	HP, 480 Vac, NEC Std, 3-ph	HP, 600 Vac, NEC Std, 3-ph	HP, 480 Vac, Time Delay, 3-ph	HP, 600 Vac, Time Delay, 3-ph	HP, 125 Vdc	HP, 250 Vdc	HP, 600 Vdc	Product Number	List Price
30A	NEMA Type 12	5	7 1/2	15	20	-	5	-	TH3361M	\$627.00
60A	NEMA Type 12	15	15	30	50	5	10	-	TH3362M	\$647.00
100A	NEMA Type 12	25	30	60	75	-	20	-	TH3363M	\$1006.00
200A	NEMA Type 12	50	60	125	150	-	40	-	TH3364M	\$1619.00
400A	NEMA Type 12	100	125	250	350	-	50	-	TH3365M	\$3599.00
600A	NEMA Type 12	150	200	400	500	-	50	-	TH3366M	\$6004.00
30A	NEMA Type 4/4X	5	7 1/2	15	20	-	5	-	TH3361MSS	\$1762.00
60A	NEMA Type 4/4X	15	15	30	50	5	10	-	TH3362MSS	\$1941.00
100A	NEMA Type 4/4X	25	30	60	75	-	20	-	TH3363MSS	\$3867.00
200A	NEMA Type 4/4X	50	60	125	150	-	40	-	TH3364MSS	\$5417.00
400A	NEMA Type 4/4X	100	125	250	350	-	50	-	TH3365MSS	\$10307.00
600A	NEMA Type 4/4X	150	200	400	500	-	50	-	TH3366MSS	\$14278.00

<sup>1</sup>All mill duty switches accept neutral and auxiliary contact kits. Order from page 2-26.

**Publications and Reference:** See Section 21 for a list of additional product-related publications





**Mill Duty, Type TH**  
 Spec-Setter Safety Switches  
 300-600 Amperes  
 240, 480, 600 Volts AC  
 250, 600 Volts DC

**Three-pole, 480 and 600 Volts ac – 250 Volts dc Fusible With Viewing Window** GO-131B

Ampere Rating	Enclosure Type <sup>1</sup>	HP, 240 Vac, NEC Std, 1-ph	HP, 240 Vac, NEC Std, 3-ph	HP, 480 Vac, Time Delay, 3-ph	HP, 600 Vac, Time Delay, 3-ph	HP, 125 Vdc	HP, 250 Vdc	HP, 600 Vdc	Product Number	List Price
30	NEMA Type 12	5	7 1/2	15	20	–	5	–	TH3361MW	\$654.00
60	NEMA Type 12	15	15	30	50	5	10	–	TH3362MW	\$669.00
100	NEMA Type 12	25	30	60	75	–	20	–	TH3363MW	\$984.00
200	NEMA Type 12	50	60	125	150	–	40	–	TH3364MW	\$1524.00

**Two-pole, 600 Volts dc, No Fuse** GO-131B

Ampere Rating	Enclosure Type <sup>1</sup>	HP, 240 Vac, NEC Std, 1-ph	HP, 240 Vac, NEC Std, 3-ph	HP, 480 Vac, Time Delay, 3-ph	HP, 600 Vac, Time Delay, 3-ph	HP, 125 Vdc	HP, 250 Vdc	HP, 600 Vdc	Product Number	List Price
30A	NEMA Type 12	–	–	–	–	–	–	15	THN2261MDC	\$466.00
60A	NEMA Type 12	–	–	–	–	–	–	25	THN2262MDC	\$483.00
100A	NEMA Type 12	–	–	–	–	–	–	25	THN2263MDC	\$742.00
30A	NEMA Type 4/4X	–	–	–	–	–	–	15	THN2261MSSDC	\$1484.00
60A	NEMA Type 4/4X	–	–	–	–	–	–	25	THN2262MSSDC	\$1760.00
100A	NEMA Type 4/4X	–	–	–	–	–	–	25	THN2263MSSDC	\$3599.00

**Three-pole, 480 and 600 Volts ac - 250 Volts dc, No Fuse** GO-131B

Ampere Rating	Enclosure Type <sup>1</sup>	HP, 240 Vac, NEC Std, 1-ph	HP, 240 Vac, NEC Std, 3-ph	HP, 480 Vac, Time Delay, 3-ph	HP, 600 Vac, Time Delay, 3-ph	HP, 125 Vdc	HP, 250 Vdc	HP, 600 Vdc	Product Number	List Price
30A	NEMA Type 12	3	10	20	30	3	5	–	THN3361M	\$500.00
60A	NEMA Type 12	10	20	50	60	5	10	–	THN3362M	\$517.00
100A	NEMA Type 12	20	40	75	100	–	20	–	THN3363M	\$803.00
200A	NEMA Type 12	30	60	125	150	–	40	–	THN3364M	\$1082.00
400A	NEMA Type 12	–	125	250	350	–	50	–	THN3365M	\$2881.00
600A	NEMA Type 12	–	200	400	500	–	50	–	THN3366M	\$4804.00
30A	NEMA Type 4/4X	3	10	20	30	3	5	–	THN3361MSS	\$1482.00
60A	NEMA Type 4/4X	10	20	50	60	5	10	–	THN3362MSS	\$1762.00
100A	NEMA Type 4/4X	20	40	75	100	–	20	–	THN3363MSS	\$3604.00
200A	NEMA Type 4/4X	30	60	125	150	–	40	–	THN3364MSS	\$4917.00
400A	NEMA Type 4/4X	–	125	250	350	–	50	–	THN3365MSS	\$9852.00
600A	NEMA Type 4/4X	–	200	400	500	–	50	–	THN3366MSS	\$13207.00

<sup>1</sup>All mill duty switches accept neutral and auxiliary contact kits. Order from page 2-26.

SAFETY SWITCHES

2



Accessories and Lug Sizes: See pages 2-25 to 2-30  
 Outlines, Dimensions and Knockouts: See pages 2-31 to 2-39

## Double-Throw Switches

Spec-Setter Safety Switches

Type TC, Type TDT

240, 480, 600 Volts AC

250 Volts DC

### Type TC Indoor Double-Throw Switches

- Designed for application where safety, high performance, and continuity of service are required.
- UL Listed. Products in this section have been tested by UL and shown to meet the construction and performance requirements of UL Standard Number 98, Enclosed and Dead Front Switches. Suitable for use in accordance with Article 702 of the National Electrical Code.
- Meet Federal Specification W-S-865C for enclosed switches; 30-200 amps, Type HD; 400-600 amps, Type LD.
- Meet or exceed NEMA Enclosed Switch Standard KS1-1990 except paragraph 1-4.24 (withstand and short circuit) for Type HD 30-200 amps, Type GD 400-600 amps.
- 60°C and 75°C conductor ratings.
- Quick-make, quick-break mechanisms 30-200 amps; quick break mechanisms 400-600 amps.
- Not service entrance rated. UL listed neutral not available.

### Type TC Outdoor Emergency Power Transfer Switches

- Designed for residential or light commercial applications where duty is not severe.
- UL Listed. Products in this section have been tested by UL and shown to meet the construction and performance requirements of UL Standard Number 98, Enclosed and Dead Front Switches.
- Meet or exceed NEMA Enclosed Switch Standard KS1-1983 for Type GD.
- Suitable for use as service entrance equipment when installed in accordance with National Electrical Code.
- 60°C and 75°C conductor ratings.
- Not quick-make, quick-break

### Type TDT Fusible Double-Throw Safety Switches

- TDT safety switches are suitable for use as service entrance equipment when either neutral kit DT200NK or ground lug kit DS200GK is installed.

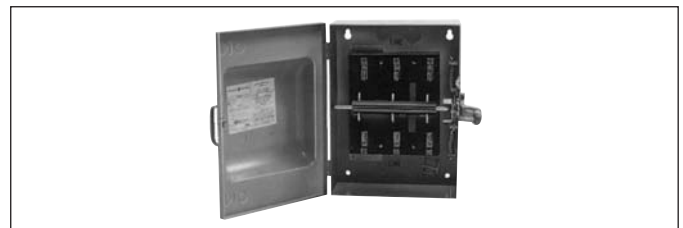

TC35322, Type TC Indoor Double-throw Switch



TC10323R, Type TC Outdoor Emergency Power Transfer Switch

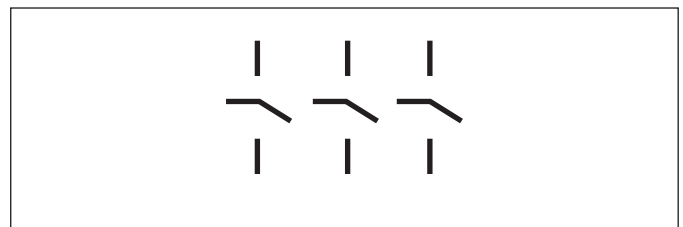

Three-pole, 240 Volts ac, 250 Volts dc, No Fuse

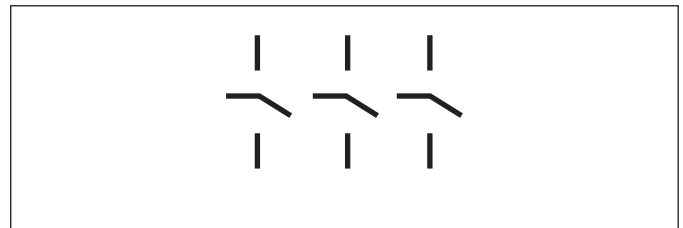

Three-pole, 600 Volts ac, 250 Volts dc, No Fuse



Three-wire SN, 120/240 Volts ac, No Fuse

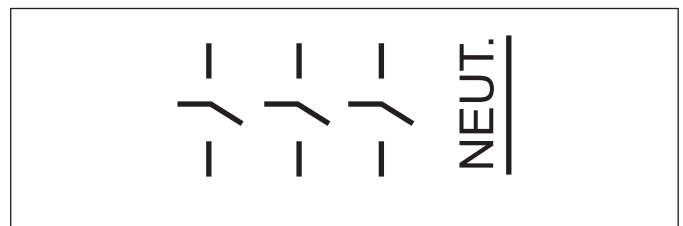

Four-wire SN, 240 Volts ac, No Fuse

Publications and Reference: See Section 21 for a list of additional product-related publications



## Double-Throw Switches

Spec-Setter Safety Switches

Type TC, Type TDT

240, 480, 600 Volts AC

250 Volts DC

### Three-pole, 240 Volts ac, 250 Volts dc, No Fuse

GO-131B

Ampere Rating	Enclosure Type	HP, 240 Vac, NEC Std, 3-ph	HP, 480 Vac, NEC Std, 3-ph	HP, 600 Vac, NEC Std, 3-ph	Lug Wire Size, AWG/kcmil, Cu Only	Product Number	List Price
30A	NEMA Type 1	2	-	-	14-8	TC35321	\$482.00
60A	NEMA Type 1	3	-	-	14-4	TC35322	\$707.00
100A	NEMA Type 1	7 1/2	-	-	14-1/0	TC35323	\$1156.00
200A	NEMA Type 1	15	-	-	6-250	TC35324	\$1825.00
400A	NEMA Type 1	30	-	-	(2)1/0-250 or #2-600	TC35325	\$4967.00
600A	NEMA Type 1	50	-	-	(2)3/0-350 or #2-600	TC35326	\$6665.00

### Three-pole, 600 Volts ac, 250 Volts dc, No Fuse

GO-131B

Ampere Rating	Enclosure Type	HP, 240 Vac, NEC Std, 3-ph	HP, 480 Vac, NEC Std, 3-ph	HP, 600 Vac, NEC Std, 3-ph	Lug Wire Size, AWG/kcmil, Cu Only	Product Number	List Price
30A	NEMA Type 1	10	10	10	14-4	TC35362	\$810.00
60A	NEMA Type 1	10	10	10	14-4	TC35362	\$810.00
100A	NEMA Type 1	15	15	15	14-1/0	TC35363	\$1281.00
200A	NEMA Type 1	30	30	30	6-250	TC35364	\$1960.00
400A	NEMA Type 1	-	-	-	(2)1/0-250 or #2-600	TC35365 <sup>1</sup>	\$5063.00
600A	NEMA Type 1	-	-	-	(2)3/0-350 or #2-600	TC35366 <sup>1</sup>	\$7329.00

### Solid Neutrals - Factory Installation Only, Not Field Installable. NOT UL LISTED.

GO-131

Switch Ampere Rating	Product Number	List Price Adder
30-100	Order by Description	\$72.00
200-600		\$161.00

### 240 Volts ac, Fusible

GO-131B

Ampere Rating	Enclosure Type	HP, 240 Vac, Time Delay, 1-ph	HP, 480 Vac, Time Delay, 1-ph	HP, 600 Vac, Time Delay, 1-ph	HP, 240 Vac, Time Delay, 3-ph	HP, 480 Vac, Time Delay, 3-ph	HP, 600 Vac, Time Delay, 3-ph	HP, DC @ 250V	Product Number	List Price
30A	NEMA Type 1	3	7 1/2	10	7 1/2	15	20	5	TDT3321	\$1033.00
60A	NEMA Type 1	10	20	25	15	30	50	10	TDT3322	\$1877.00
100A	NEMA Type 1	15	30	40	30	60	75	20	TDT3323	\$3100.00
200A	NEMA Type 1	15	50	50	60	125	150	40	TDT3324 <sup>2</sup>	\$4466.00
400A	NEMA Type 1	-	-	-	125	100	125	50	TDT3325 <sup>3</sup>	\$9473.00
600A	NEMA Type 1	-	-	-	75	-	-	50	TDT3326 <sup>3</sup>	\$11958.00
30A	NEMA Type 3R	3	7 1/2	10	7 1/2	15	20	5	TDT3321R	\$1625.00
60A	NEMA Type 3R	10	20	25	15	30	50	10	TDT3322R	\$2408.00
100A	NEMA Type 3R	15	30	40	30	60	75	20	TDT3323R	\$3242.00
200A	NEMA Type 3R	15	50	50	60	125	150	40	TDT3324R <sup>1</sup>	\$5753.00

### 600 Volts ac, Fusible

GO-131B

Ampere Rating	Enclosure Type	HP, 240 Vac, Time Delay, 1-ph	HP, 480 Vac, Time Delay, 1-ph	HP, 600 Vac, Time Delay, 1-ph	HP, 240 Vac, Time Delay, 3-ph	HP, 480 Vac, Time Delay, 3-ph	HP, 600 Vac, Time Delay, 3-ph	HP, DC @ 250V	Product Number	List Price
30A	NEMA Type 1	3	7 1/2	10	7 1/2	15	20	5	TDT3361	\$2088.00
60A	NEMA Type 1	10	20	25	15	30	50	10	TDT3362	\$2103.00
100A	NEMA Type 1	15	30	40	30	60	75	20	TDT3363	\$3708.00
200A	NEMA Type 1	15	50	50	60	125	150	40	TDT3364 <sup>2</sup>	\$5492.00
400A	NEMA Type 1	-	-	-	125	100	125	50	TDT3365	\$9704.00
100A	NEMA Type 3R	15	30	40	30	60	75	20	TDT3363R	\$4132.00
200A	NEMA Type 3R	15	50	50	60	125	150	40	TDT3364R <sup>2</sup>	\$6141.00

<sup>1</sup>Not UL Listed, not suitable for use in accordance with Article 702 of the National Electrical Code.

<sup>2</sup>200 A switches move load bases for Class J fuses.

<sup>3</sup>600A switch available with only Class T fuse provisions.



Accessories and Lug Sizes: See pages 2-25 to 2-30  
 Outlines, Dimensions and Knockouts: See pages 2-31 to 2-39

SAFETY SWITCHES

2

## Double-Throw Switches

Spec-Setter Safety Switches

Type TC Outdoor

240, 480, 600 Volts AC

250 Volts DC

### Three-wire SN, 120/240 Volts ac, No Fuse—Emergency Power Transfer Switch GO-131A

Ampere Rating	Enclosure Type <sup>2</sup>	Lug Wire Size, AWG/kcmil, Cu/Al	Product Number	List Price
100A	NEMA Type 3R	12-1	TC10323R	\$501.00
200A	NEMA Type 3R	6-250	TC10324R	\$1336.00

### Four-wire SN, 240 Volts ac, No Fuse—Emergency Power Transfer Switch GO-131A

Ampere Rating	Enclosure Type <sup>2</sup>	Lug Wire Size, AWG/kcmil, Cu/Al	Product Number	List Price
200A	NEMA Type 3R	6-250	TC10424R	\$1832.00

### Accessories for TDT-Style Fusible Double-Throw Safety Switches (Standard Delivery—4 Weeks) GO-131B

Accessory Type	Description	Product Number	List Price
Control Pole	-	DS16CP	\$193.00
Electrical Interlocks	30-800 A, 1N	DS200EK1	\$261.00
Electrical Interlocks	30-800 A, 2N	DS200EK2	\$523.00
Neutral Kit	30-100 A	DT100NK	\$144.00
Neutral Kit	200 A	DT200NK	\$235.00
Neutral Kit	400-800 A	DS800NK	\$564.00
Class J Fuse Field Conversion Kit	400 A (600 V only)	DT400JK	\$499.00
Equipment Ground Kits	30-100 A Kit	DS100GK	\$9.25
Equipment Ground Kits	200 A Kit	DS200GK	\$105.00
Equipment Ground Kits	400-800 A Kit	DS468GK	\$210.00
Class R Fusing Kit—Field Installable	for 3 Poles 30 A (240V)	DS12FK	\$20.25
Class R Fusing Kit—Field Installable	for 3 Poles 30 & 60 A	DS16FK	\$20.25
Class R Fusing Kit—Field Installable	for 3 Poles 60 A (600V)	DS26FK	\$20.25
Class R Fusing Kit—Field Installable	for 3 Poles 100 A (240V & 600V)	DS36FK	\$39.00
Class R Fusing Kit—Field Installable	for 3 Poles 200 A (240V & 600V)	DS46FK	\$57.75
Class R Fusing Kit—Field Installable	for 3 Poles 400 A (240V & 600V)	DS56FK	\$98.00
Class R Fusing Kit—Field Installable	for 3 Poles 600A (240V & 600V)	DS66FK	\$98.00
T Fuse Clip	for 3 Pole 200A (240V)	DS426TK	\$67.50
T Fuse Clip	for 3 Pole 200A (600V)	DS466TK	\$87.50
T Fuse Clip	for 1 Pole 400A (240V)	DS526TK <sup>1</sup>	\$57.50
T Fuse Clip	for 1 Pole 400A (600V)	DS566TK <sup>1</sup>	\$84.50
T Fuse Clip	for 1 Pole 600A (240V)	DS626TK <sup>1</sup>	\$67.50
T Fuse Clip	for 1 Pole 600A (600V)	DS666TK <sup>1</sup>	\$96.00

<sup>1</sup>Order one kit per pole.

<sup>2</sup>Devices may have removable closing cap. Order hubs separately. See page 2-30.

**Publications and Reference:** See Section 21 for a list of additional product-related publications



## Special Purpose Heavy Duty, Type TH

### Spec-Setter Safety Switches

#### Six-pole Switches

GO-131

- UL Listed. Products in this section have been tested by UL and shown to meet the construction and performance requirements of UL Standard Number 98, Enclosed and Dead Front Switches.
- Single enclosure rated Type 1, 3R and 12.
- Drip hood included.
- Furnished without knockouts or hubs. Order hubs separately (see page 2-30).
- Horsepower rated.
- Quick-make, quick-break.
- Full cover interlocks.
- Equipment ground provided.
- Suitable for four-pole applications.
- 60°C and 75°C conductor ratings.

#### Fusing—UL Listed

- Class H (10,000 rms amps, sym IC) standard.
- Class J (200,000 rms amps, sym IC). See page 2-29 for field conversion details.
- Class R (200,000 rms amps, sym IC). Order appropriate Class R fusing kit (2 kits per switch) from table below.

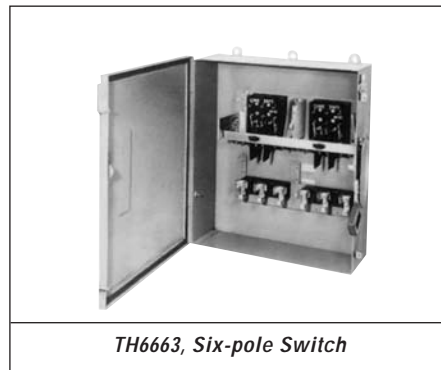

TH6663, Six-pole Switch

System Voltage	Fusible	Ampere Rating	Product Number	List Price
240Vac, 250Vdc	Yes	30A	TH6621	\$2303.00
240Vac, 250Vdc	Yes	60A	TH6622	\$2762.00
240Vac, 250Vdc	Yes	100A	TH6623	\$3358.00
240Vac, 250Vdc	Yes	200A	TH6624	\$7555.00
250Vdc, 480Vac, 600Vac	Yes	30A	TH6661	\$2303.00
250Vdc, 480Vac, 600Vac	Yes	60A	TH6662	\$2762.00
250Vdc, 480Vac, 600Vac	Yes	100A	TH6663	\$3358.00
250Vdc, 480Vac, 600Vac	Yes	200A	TH6664	\$7555.00
250Vdc, 480Vac, 600Vac	No	30A	THN6661	\$2048.00
250Vdc, 480Vac, 600Vac	No	60A	THN6662	\$2372.00
250Vdc, 480Vac, 600Vac	No	100A	THN6663	\$2919.00
250Vdc, 480Vac, 600Vac	No	200A	THN6664	\$6564.00

#### Optional Neutrals

GO-131

Switch Rating (Amperes)	Switch Rating (Volts)	Product Number	List Price
30/60	240/600	TNI62	\$35.00
100	240-600	TNI63	\$108.00
200	240-600	TNIJ64	\$132.00

#### Class R Fuse Kits

GO-143

Ampere Rating	System Voltage	Product Number	List Price
30A	240V	TPBRK12A	\$35.00
30A	600V	TPBRK16A	\$35.00
60A	240V	TPBRK22A	\$35.00
60A	600V	TPBRK26A	\$35.00
100A	240Vac-600Vac	TPBRK36A	\$35.00
200A	240Vac-600Vac	TRK46A <sup>1</sup>	\$43.25

<sup>1</sup>GO-131

Accessories and Lug Sizes: See pages 2-25 to 2-30  
 Outlines, Dimensions and Knockouts: See pages 2-31 to 2-39



## Special Purpose Heavy Duty, Type TH Spec-Setter Safety Switches

### Interlocked Receptacle Switches

GO-131

- UL Listed. Products in this section have been tested by UL and shown to meet the construction and performance requirements of UL Standard Number 98, Enclosed and Dead Front Switches.
- Meet NEMA Enclosed Safety Switch Standard KS1-1990 for Type HD.
- Type 12 enclosure.
- Furnished without knockouts or hubs. Order hubs separately (see page 2-30).
- Quick-make, quick-break.
- Full cover interlocks.
- 60°C and 75°C conductor ratings.
- Meet horsepower ratings and descriptive data on pages 2-7 through 2-13.

#### Fusing—UL Listed

- Class H (10,000 rms amps, sym IC) standard.
- Class J (100,000 rms amps, sym IC). See page 2-29 for field conversion details.
- Class R (100,000 rms amps, sym IC). Order appropriate Class R fusing kit from page 2-29.
- Typical application: Portable power supply connection during building construction.
- Interlocked receptacle switches are equipped with 60-amp, three-phase, three-wire grounded type receptacle, prewired and mounted with an interlock linkage to the switch mechanism. The interlock linkage is designed to deter insertion or removal of the plug while the switch is in the "ON" position. It also prevents operation of the switch unless the mating plug is inserted.

**Note:** Both the Crouse Hinds and the Russellstoll receptacles use mating plugs that are not supplied with the switch. These can be ordered directly from Crouse Hinds or Russellstoll, a division of M-R-S Power Systems.

Fusible	Receptacle Manufacturer	Mating Plug	Ampere Rating	Product Number	List Price
Yes	Crouse Hinds	Arktite #APJ6485	60A	TH3362JCH	\$3020.00
Yes	Russellstoll	Heavy Service Ever-Lok #8414	60A	TH3362JRS	\$4515.00
No	Crouse Hinds	Arktite #APJ6485	60A	THN3362JCH	\$2843.00

Arktite is a registered trademark of Crouse Hinds Co. Ever-Lok is a registered trademark of the Russellstoll product line.

### Copper Lug Switches—Three-pole, Fusible, 480, 600, 480/277 Volts ac, 250 Volts dc GO-131

- Copper-bodied lugs factory installed.
- Meets major automotive specification (GM Specification 21-04, GM Saturn, Ford and Chrysler).
- Suitable for non-silicone applications.
- Type 1, 4/4X and 12 enclosures.
- Meets horsepower ratings and descriptive data on pages 2-7 through 2-13.

Ampere Rating	Enclosure Type	Product Number	List Price
30A	NEMA Type 1	THR3361CL <sup>1</sup>	\$440.00
60A	NEMA Type 1	THR3362CL	\$531.00
100A	NEMA Type 1	THR3363CL	\$969.00
200A	NEMA Type 1	THR3364CL	\$1453.00
400A	NEMA Type 1	THR3365CL	\$2457.00
600A	NEMA Type 1	THR3366CL	\$6270.00
30A	NEMA Type 4/4X	THR3361SSCL	\$1780.00
60A	NEMA Type 4/4X	THR3362SSCL	\$1970.00
100A	NEMA Type 4/4X	THR3363SSCL	\$3919.00
200A	NEMA Type 4/4X	THR3364SSCL	\$5532.00
400A	NEMA Type 4/4X	THR3365SSCL	\$10848.00
600A	NEMA Type 4/4X	THR3366SSCL	\$15581.00
30A	NEMA Type 12	THR3361JCL <sup>1</sup>	\$686.00
60A	NEMA Type 12	THR3362JCL <sup>1</sup>	\$717.00
60A	NEMA Type 12	THR3362JCHCL <sup>2</sup>	\$1771.00
100A	NEMA Type 12	THR3363JCL <sup>1</sup>	\$1119.00
200A	NEMA Type 12	THR3364JCL <sup>1</sup>	\$1821.00
400A	NEMA Type 12	THR3365JCL <sup>1</sup>	\$4032.00
600A	NEMA Type 12	THR3366JCL <sup>1</sup>	\$6823.00

<sup>1</sup>Change prefix to "TH" for class H fusing. Consult sales office for price and availability.

<sup>2</sup>Includes interlocked receptacle.

Registered trademark under the Russellstoll product line.

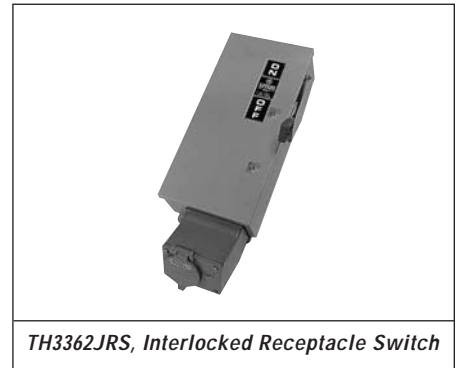

TH3362JRS, Interlocked Receptacle Switch

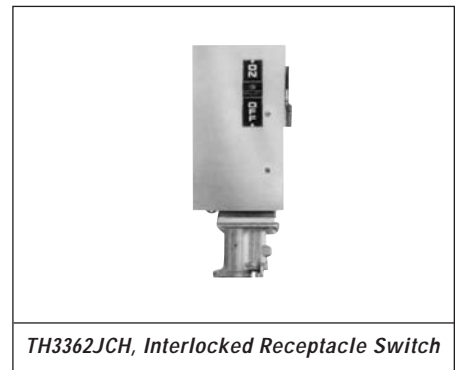

TH3362JCH, Interlocked Receptacle Switch



THR3362JCL, Copper Lug Switch

**Publications and Reference:** See Section 21 for a list of additional product-related publications



## Special Purpose Heavy Duty, Type TH

Spec-Setter Safety Switches

**Copper Lug Switches—Three-pole, No Fuse, 480, 600, 480/277 Volts ac, 250 Volts dc GO-131**

Ampere Rating	Enclosure Type	Product Number	List Price
30A	NEMA Type 1	THN3361CL	\$232.00
60A	NEMA Type 1	THN3362CL	\$412.00
100A	NEMA Type 1	THN3363CL	\$649.00
200A	NEMA Type 1	THN3364CL	\$1044.00
400A	NEMA Type 1	THN3365CL	\$2343.00
600A	NEMA Type 1	THN3366CL	\$4227.00
30A	NEMA Type 4/4X	THN3361SSCL	\$1493.00
60A	NEMA Type 4/4X	THN3362SSCL	\$1777.00
100A	NEMA Type 4/4X	THN3363SSCL	\$3611.00
200A	NEMA Type 4/4X	THN3364SSCL	\$5195.00
400A	NEMA Type 4/4X	THN3365SSCL	\$10068.00
600A	NEMA Type 4/4X	THN3366SSCL	\$13729.00
30A	NEMA Type 12	THN3361JCL	\$561.00
60A	NEMA Type 12	THN3362JCL	\$725.00
60A	NEMA Type 12	THN3362JCHCL <sup>1</sup>	\$1650.00
100A	NEMA Type 12	THN3363JCL	\$1031.00
200A	NEMA Type 12	THN3364JCL	\$1367.00
400A	NEMA Type 12	THN3365JCL	\$3410.00
600A	NEMA Type 12	THN3366JCL	\$5524.00

Consult sales office for dimensions.

<sup>1</sup>Includes interlocked receptacle.



Accessories and Lug Sizes: See pages 2-25 to 2-30  
 Outlines, Dimensions and Knockouts: See pages 2-31 to 2-39



## Definite Purpose

### Spec-Setter Safety Switches

#### Thermoplastic Plug-fuse Type TC Switches GO-131A

- Designed for residential or light commercial applications where duty is not severe.
- UL Listed. Products in this section have been tested by UL and shown to meet the construction and performance requirements of UL Standard Number 98, Enclosed and Dead Front Switches.
- Meet or exceed NEMA Enclosed Switch Standard KS1-1990 for Type GD.
- 30 ampere maximum.
- Copper wire only, 14-10 AWG.
- GE Valox resin.

Enclosure Type	No. of Poles	System Voltage	HP, 240 Vac, NEC Std, 1-ph	HP, 240 Vac, Time Delay, 1-ph	Product Number	List Price
NEMA Type 1	1	120Vac	1 1/2	3	TPF130	\$43.25
NEMA Type 1	2	240Vac	1 1/2	3	TPF230	\$59.00

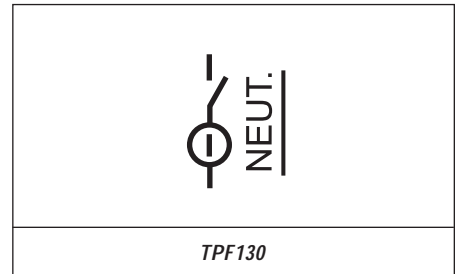

TPF130

#### Manual Motor Starters GO-131B

- Toggle operated tumbler.
- No overload protection.
- Copper wire only, 14-10 AWG. UL Listed.
- Can be used with Arrow-Hart flush plate #7949.

Enclosure Type	No. of Poles	Ampere Rating	System Voltage	HP, 120 Vac	HP, 240 Vac	HP, 480 Vac	HP, 600 Vac	HP, 250 Vdc	Standard Package	Product Number	List Price
NEMA Type 1	2	20A	240Vac 250Vdc 480Vac	—	2	2	—	2	50 to Ctn.	TC2228	\$72.00
NEMA Type 1	3	20A 30A	240Vac 600Vac	3	7 1/2	15	15	—	50 to Ctn.	TC2368	\$172.00
None	2	30A	250Vac	—	2	2	—	2	50 to Ctn.	TC2228S	\$57.25
None	3	30A 20A	240Vac 600Vac	3	7 1/2	15	—	15	50 to Ctn.	TC2368S	\$155.00

Not "T" or "L" rated switch

Arrow-Hart is a registered trademark of Cooper Industries.

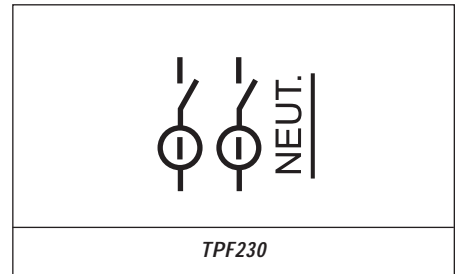

TPF230

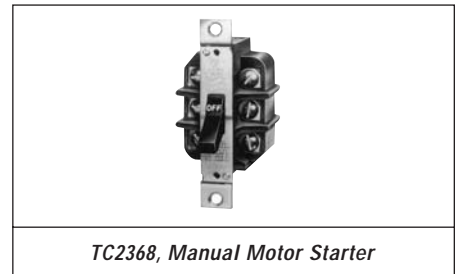

TC2368, Manual Motor Starter

**Publications and Reference:** See Section 21 for a list of additional product-related publications



## AC Disconnects

Spec-Setter Safety Switches

### Air Conditioner Disconnects

GO-131AC

—Puller type

—UL Listed

Fusible – UL869

Service Equipment

No fuse – UL1429

Enclosed Pull-out Switch

Enclosure Type <sup>1</sup>	Enclosure Material	Fusible	Ampere Rating	System Voltage	Horsepower Rating	Lug Wire		Product Number	List Price
						Range	AWG Standard		
NEMA Type 3R	Thermoplastic	Yes	30A	120/240Vac	3	14-3	6	TPF30R	\$112.00
NEMA Type 3R	Thermoplastic	Yes	60A	120/240Vac	10	14-3	6	TPF60R	\$112.00
NEMA Type 3R	Thermoplastic	No	60A	240Vac	10	14-3	6	TPN60R1	\$96.00
NEMA Type 3R	Thermoplastic	Non-automatic	60A	240Vac	10	14-3	6	TPNA60R1	\$121.00
NEMA Type 3R	Steel	Yes	30A	240Vac	3	14-3	6	TF30R	\$102.00
NEMA Type 3R	Steel	Yes	60A	240Vac	10	14-3	6	TF60R	\$102.00
NEMA Type 3R	Steel	No	60A	240Vac	10	14-3	6	TFN60R	\$86.00
NEMA Type 3R	Steel	Non-automatic	60A	240Vac	10	14-3	6	TNA60R1	\$111.00
NEMA Type 3R	Steel	No	60A	240Vac	10	14-3	6	TFN60RGFR <sup>2</sup>	\$300.00
NEMA Type 3R	Steel	Non-automatic	60A	240Vac	10	14-3	6	TNA60RGFR <sup>2</sup>	\$325.00

<sup>1</sup>Devices do not have removable closing cap.

<sup>2</sup>These AC disconnects include a GFCI outlet.



TPF60R, Air Conditioner Disconnect, Thermoplastic Enclosure



TFN60R, Air Conditioner Disconnect, Steel Enclosure



TNA60RGFR



TFN60RGFR

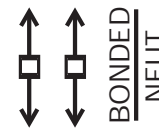

Fusible

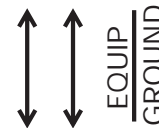

No Fuse



Non-automatic



Accessories and Lug Sizes: See pages 2-25 to 2-30  
 Outlines, Dimensions and Knockouts: See pages 2-31 to 2-39

## Accessories: NEMA Type 1 and 3R Enclosures

Spec-Setter Safety Switches

30-600 Amperes: TG and TH

800-1200 Amperes: TC

Equipment Ground Kits					GO-137A
Ampere Rating	Wire Range AWG/kcmil Copper	Wire Range AWG/kcmil Aluminum	Standard Package	Product Number	List Price
30A	(4) 14-8, (3) 14-4	(4) 14-8, (3) 6-4	20	TGL1	\$10.00
60A					
100A	(3) 10-1/0	(3) 10-1/0	1	TNG3	\$60.00
200A					
600A	(3) 2-250	(3) 2-250	1	TGL6 <sup>1</sup>	\$68.25
400A					

<sup>1</sup>GO-131

Neutral Kit Insulated, Groundable and Bondable							GO-131
Ampere Rating	System Voltage	Fusible	Wire Range AWG/kcmil Copper	Wire Range AWG/kcmil Aluminum	Standard Package	Product Number	List Price
30A	240Vac					TNI21	\$50.75
30A	600Vac		12-2	12-2	1	TNI62 <sup>2</sup>	\$50.75
60A		Yes	12-2	12-2	1	TNIA62	\$50.75
100A		Yes	10-1/0	10-1/0	1	TNIA63	\$108.00
100A		No	10-1/0	10-1/0	1	TNI63 <sup>2</sup>	\$108.00
200A			2-250	2-250	1	TNIA64	\$132.00
400A			(1) 2-600 or (2) 1/0-250	(1) 2-600 or (2) 1/0-250	1	TNI65	\$232.00
400A			(1) 2-600 or (2) 1/0-250	(1) 2-600 or (2) 1/0-250	1	TNI65A	\$232.00
600A			(2) 4-500	(2) 4-500	1	TNI66	\$232.00
800A			(3) 2-600 or (6) 1/0-250	(3) 2-600 or (6) 1/0-250	1	TNI67	\$490.00
1200A			(4) 3/0-800	(4) 3/0-800	1	TNI68A	\$675.00

**Switching Neutral:** Order standard switch of required number of poles and use dummy fuse in neutral pole.

<sup>2</sup>Not suitable for type TG switches.

### Lug Wire Sizes Line and Load Terminal

Ampere Rating	Wire Range AWG/kcmil Copper	Wire Range AWG/kcmil Aluminum
30A (250V)	14-8	12-8
30A (600V)	12-2	12-2
60	12-2	12-2
100	10-1/0	10-1/0
200	2-250	2-250
400	(1) 2-600 or (2) 1/0-250	(1) 2-600 or (2) 1/0-250
600	(2) 4-500	(2) 4-500
800	(3) 2-600 or (6) 1/0-250	(3) 2-600 or (6) 1/0-250
1200	(4) 3/0-800	(4) 3/0-800

**Publications and Reference:** See Section 21 for a list of additional product-related publications



## Accessories: NEMA Type 1 and 3R Enclosures

Spec-Setter Safety Switches

30-600 Amperes: TG and TH

800-1200 Amperes: TC

### Auxiliary Contact Kits

GO-131

Auxiliary contacts open before switch blades. UL Listed for field installation. Product number listed is for field installed kit.

Series Prefix	Ampere Rating	No. of Poles	Standard Package	Contacts	Contact Ratings	Product Number	List Price
TH, THN	30A	2 3	1	DPDT	10A, 125/250Vac .3A, 125Vdc .15A, 250Vdc	THAUX21D	\$135.00
TH, THN	30A	2 3	1	SPDT	15A, 125/250Vac 15A, 480/600Vac .50A, 125Vdc .25A, 250Vdc	THAUX61S	\$135.00
TH, THN	60A 100A 200A	2 3	1	DPDT	15A, 125/250Vac 15A, 480/600Vac .50A, 25Vdc .25A, 250Vdc	THAUX64D	\$193.00
TH, THN	200A	6	1	DPDT	15A, 125/250Vac 15A, 480/600Vac .50A, 125Vdc .25A, 250Vdc	THAUX66D2	\$317.00
TH, THN	30-100A 400-600A	2 3 6	1	DPDT	15A, 125/250Vac 15A, 480/600Vac .50A, 125Vdc .25A, 250Vdc	THAUX66D	\$317.00
TC	800-1200A <sup>1</sup>	2 3	-	SPDT	15A, 125/250Vac, 50A, 125Vdc, 250Vdc	-	-
TC	double throw <sup>1</sup>	-	-	SPDT	15A, 125/250Vac, 50A, 125Vdc, 25A, 250Vdc	-	-

<sup>1</sup>Not UL Listed.

### Contact Pilot Duty Ratings - 600 Volt Kits

Volts	ac			dc (Resistive)	
	Inrush Current	N.C.	N.O.	Break Normal Current	Break Normal Current
115	30	15	15	15	0.5
230	30	15	250	0.25	-
460	30	15	15	-	-
575	15	15	2	-	-

### Special Phenolic Nameplates

GO-131

(15 letters maximum)

Quantity	Product Number	List Price
1-5	75C141109P109	\$105.00
6-10	75C141109P109	\$93.00

### Semidust-tight Door Gasket Kits

GO-131

Types TH Indoor, TG and TH Outdoor Switches. Product Number listed is for field mounted kit.

Ampere Rating	Standard Package	Product Number	List Price
30A 60A 100A	1	THG106	\$35.50
200A	1	THG107	\$68.25
600A 400A	1	THG108	\$92.00



## Accessories: NEMA Type 4/4X, 12 and Mill Duty Enclosures

Spec-Setter Safety Switches  
30-600 Amperes: TH

### Lug Wire Sizes

#### Line and Load Terminals

Switch Ampere Rating	Factory Installed		Field Installed Crimp Lugs (See Table on page 2-28)	
	Copper	Aluminum	Copper	Aluminum
30A-240V	14-8	12-8	-	-
30A-600V	14-6	14-6	14-8	-
60	14-2	14-2	8-4	-
100	14-1/0	12-1/0	6-1/0	6-2/0
200	6-250	-	1/0-250	-
400	(1) 2-600 or (2) 1/0-250	-	(2) 300-600 or (1) 750	(2) 250-600 or (1) 750
600	(2) 4-600	-	(2) 300-600 or (1) 750	(2) 250-600 or (1) 750

#### Equipment Ground Terminals—Two lugs supplied per switch, provision for one additional lug.

Ampere Rating	Copper	Aluminum	Copper	Aluminum
30	14-6	14-6	14-8	-
60	14-6	14-6	14-8	-
100	14-4	14-4	8	6
200	14-4	14-4	6	4
400	14-1/0	12-1/0	3-2	1
600	14-2/0	14-2/0	1	2/0

### Auxiliary Contact Kits

GO-131

Auxiliary contacts designed to open before switch blades. UL Listed for field installation. Product number listed is for field installed kit.

Series Prefix	Ampere Rating	System Voltage	Standard Package	Contacts	Product Number	List Price
TH, THN	30A	240V	1	DPDT	THAUX21D	\$135.00
TH, THN	30A	240V	1	SPDT	THAUX61S	\$135.00
TH, THN	30A	600V	1	DPDT	THAUX64D	\$193.00
	60-200A	240-600V				
TH, THN	400-600A	240-600V	1	DPDT	THAUX66D	\$317.00

For Contact Pilot Duty Ratings, see page 2-26.

### Optional Copper Lug Neutrals

GO-131

Ampere Rating	Fusible	Lug Wire Size, AWG/kcmil, Cu Only	Standard Package	Product Number	List Price
30A-60A	Yes	14-2	1	TNIJ62CL	\$72.50
30A-60A	No	14-2	1	TNIJA62CL	\$72.50
100A	-	14-1/0	1	TNIJ63CL	\$148.00
200A	-	1/0-250	1	TNIJ64CL	\$176.00
400-600A	-	(2) 1/0-600	1	TNIJ66CL	\$322.00

### Neutral Kit Insulated, Groundable and Bondable

GO-131

Ampere Rating	System Voltage	Fusible	Lug Wire Size AWG/kcmil Factory Installed Aluminum	Lug Wire Size AWG/kcmil Factory Installed Copper	Lug Wire Size AWG/kcmil Field Installed Crimp Lugs Copper	Lug Wire Size AWG/kcmil Field Installed Crimp Lugs Aluminum	Standard Package	Product Number	List Price
30A	240Vac	Yes	12-8	14-8	-	-	-	TNIJ21	\$50.75
30A	600Vac <sup>1</sup>	Yes/No	14-6	14-6	14-8	-	1	TNIJ61	\$50.75
60A	600Vac <sup>2</sup>	Yes	14-2	14-2	8-4	-	1	TNIJ62	\$50.75
60A	240Vac <sup>2</sup>	Yes	14-2	14-2	8-4	-	1	TNIJ62	\$50.75
60A	600Vac	Yes	14-2	14-2	8-4	-	1	TNIJ62	\$50.75
60A	600Vac <sup>2</sup>	No	14-2	14-2	8-4	-	1	TNIJA62	\$50.75
60A	600Vac	No	14-2	14-2	8-4	-	1	TNIJA62	\$50.75
100A	240-600Vac	-	12-1/0	14-1/0	6-1/0	6-2/0	1	TNIJ63	\$108.00
200A	240-600Vac	-	6-250	6-250	1/0-250	1/0-250	1	TNIJ64	\$132.00
400-600A	240-600Vac	-	(2) 4-600	(2) 4-600	(2) 300-600 or (1) 750	(2) 250-600 or (1) 750	1	TNIJ66	\$232.00

<sup>1</sup>Type 4, 4X, 12

<sup>2</sup>Mill duty type

Publications and Reference: See Section 21 for a list of additional product-related publications



## Accessories: NEMA Type 4/4X, 12 and Mill Duty Enclosures

Spec-Setter Safety Switches

30-600 Amperes: TH

### Crimp-type Connectors - Field Replaceable

(Obtain from normal source. Not furnished with switches.)

### Line and Load Terminals

Switch Ampere Rating	Lug Wire Size AWG/kcmil	Thomas and Betts Product Number		Burdny Product Number	
		Copper	Aluminum	Copper	Aluminum
30	14-12	-	-	YAV12 G2	-
30	12-10	-	-	YAV10	-
30	8	54104	-	YAV8C-L	-
60	8	54130	-	YAV8C-L1	-
60	6	54105	-	YAV6C-L	-
60	4	54106	-	YAV4CLY1	-
100	6	54105	60107	-	-
100	4	54106	60112	-	-
100	2	54017	60116	-	-
100	1	54108	60122	-	-
100	1/0	-	-	YA25-L	YA25A1
200	1/0	54153	60129	-	-
200	1/0	54109	60130	-	-
200	2/0	54158	60135	-	-
200	2/0	54110	60136	-	-
200	3/0	54163	60141	-	-
200	3/0	54111	60142	-	-
200	4/0	54168	60147	-	-
200	4/0	54112	60148	-	-
200	250	54173	60153	-	-
200	250	54174	60154	-	-
400 and 600	250	-	60156	-	-
400 and 600	300	54114	60162	-	-
400 and 600	350	54115	60165	-	-
400 and 600	400	54116	-	-	-
400 and 600	500	54118	60171	-	-
400 and 600	600	54120	60174	-	-
400 and 600	750	54123	60178	-	-

### Equipment Ground Terminals (provision for three per switch)

30	10	-	-	YAV10	-
30	8	54104	-	-	-
60	8	54104	-	YAV8C-L	-
100	8	54105	-	YAV8C-L	-
100	6	-	60106	-	-
200	6	54105	-	-	-
200	4	-	60112	-	-
400	3-2	54107	-	-	-
400	1	-	60122	-	-
600	1	54108	-	-	-
600	2/0	-	60134	-	-

SAFETY SWITCHES

2



## Accessories

### Spec-Setter Safety Switches

#### Class J Fuse Field Conversion Kit UL Listed

GO-131

TH switches, 30-400 amperes, 600 volt and 100-400 amperes, 240 volt, may be adapted to accept Class J fuses without a kit by moving the load-block toward the switch base and remounting.

One kit required per two-pole or three-pole switch.

Series Prefix	Ampere Rating	System Voltage	Product Number	List Price
TH	600A	240Vac 600Vac	THJ6	\$420.00

#### Class R Fusing Kit—Field Installable Type TH, UL Listed

GO-131

When specifications permit only Class R fuses to be used, these kits may be installed in the safety switch to deter fuses other than Class R from being installed. Kits for 30 or 60A switches incorporate replacement fuse clips. Kits for 100-600A switches incorporate rejection pins that assemble to the standard fuse clips.

Enclosure Type	Ampere Rating	System Voltage	Product Number	List Price
NEMA Type 1, 3R, 4/4X, 12	30A	240Vac	TRK12B	\$17.75
NEMA Type 1, 3R	30A	600Vac	TRK16B	\$17.25
NEMA Type 4/4X, 12	30A	600Vac	TRK16SA <sup>1</sup>	\$17.75
NEMA Type 1, 3R, 4/4X, 12	60A	240Vac	TRK22A	\$17.75
NEMA Type 1, 3R, 4/4X, 12	60A	600Vac	TRK26A	\$17.75
NEMA Type 1, 3R	100A	240Vac	TRK36A	\$31.50
		600Vac		
NEMA Type 4/4X, 12	100A	240Vac	TPBRK36A <sup>2</sup>	\$35.00
		600Vac		
NEMA Type 1, 3R, 4/4X, 12	200A	240Vac	TRK46A <sup>1</sup>	\$43.25
		600Vac		
NEMA Type 1, 3R, 4/4X, 12	400A	240Vac	TRK56A	\$74.00
		600Vac		
NEMA Type 1, 3R, 4/4X, 12	600A	240Vac	TRK66A	\$74.00
		600Vac		

<sup>1</sup>Use TRK22A on mill duty switches.

<sup>2</sup>TPBRK36A is GO-143.

**Publications and Reference:** See Section 21  
for a list of additional product-related publications





## Accessories

### Spec-Setter Safety Switches

#### Class R Fusing Kit—Field Installable Type TG, UL Listed GO-131A

When specifications permit only Class R fuses to be used, these kits may be installed in the safety switch to deter fuses other than Class R from being installed. Kits for 30 or 60A switches incorporate replacement fuse clips. Kits for 100-600A switches incorporate rejection pins that assemble to the standard fuse clips.

Enclosure Type	Ampere Rating	Product Number	List Price
NEMA Type 1, 3R	30A	TGRK12	\$17.25
NEMA Type 1, 3R	60A	TGRK22	\$17.25
NEMA Type 1, 3R	100A	TGRK32	\$31.00
NEMA Type 1, 3R	200A	TGRK42	\$74.00

#### Universal Raintight Aluminum Hubs GO-131A

For outdoor enclosures that have removable closing caps.

Nominal Conduit Diameter (in.)	Standard Package	Product Number	List Price
3/4	10	TC75	\$24.00
1	10	TC100	\$24.00
1 1/4	10	TC125	\$24.00
1 1/2	10	TC150	\$24.00
2	10	TC200	\$40.25
2 1/2	10	TC250	\$67.75



TC200 Universal Raintight Hub

#### Closing Cap for Universal Raintight Aluminum Hub GO-131A

Standard Package	Product Number	List Price
10	TCCP	\$2.60

#### Key Interlocks

Available for TH switches on special factory order in the following enclosures: Types 1, 4/4X, 12 and Mill Duty. **List Price adder \$1414.00, GO-131.** Order by description. Locks supplied. Complete coordination (lock scheme) required with order.

SAFETY SWITCHES

2



**Enclosure Dimensions**  
**Spec-Setter Safety Switches**  
**TG and TH, NEMA Type 1 and 3R Enclosures**

**NEMA Type 1 TG Approximate Dimensions in Inches Figure 1**

Product Number	Dimension W	Dimension H	Dimension D	Dimension W2	KO Figure Number <sup>1</sup>
TG3221	6 1/2	10 5/8	3 5/16	7	1
TG3222	8 1/2	13 7/8	4	9	15
TG3223	9 1/2	21 3/8	5	10	3
TG3224	13 3/4	29 1/4	5 1/2	14	4
TG3225	22	49 1/2	9	23	5
TG3226	23 1/4	50	9 1/4	23 3/4	6
TG3325	22	49 1/2	9	23	7
TG3326	23 1/4	50	9 1/4	23 3/4	6
TG4321	6 1/2	10 5/8	3 5/16	7	1
TG4322	8 1/2	13 7/8	4	9	15
TG4323	9 1/2	21 3/8	5	10	3
TG4324	13 3/4	29 1/4	5 1/2	14	4
TG4325	22	49 1/2	9	23	7
TG4326	23 1/4	50	9 1/4	23 3/4	6
TGN3321	6 1/2	10 5/8	3 5/16	7	1
TGN3322	8 1/2	13 7/8	4	9	15
TGN3323	9 1/2	21 3/8	5	10	3
TGN3324	13 3/4	29 1/4	5 1/2	14	4
TGN3325	22	49 1/2	9	23	7
TGN3326	23 1/4	50	9 1/4	23 3/4	6

<sup>1</sup>See page 2-33.

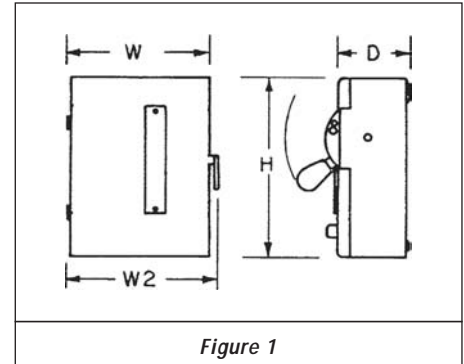

Figure 1

**NEMA Type 1 TH Approximate Dimensions in Inches Figure 2**

Product Number	Dimension W	Dimension H	Dimension D	Dimension W2	KO Figure Number <sup>1</sup>
TH3221	6 1/2	10 3/8	3 3/8	7 1/8	1
TH3222	9 1/2	17 5/8	5	10 1/8	3
TH3223	9 3/8	19 3/8	5 1/16	10 1/4	3
TH3224	13 1/2	25 3/8	5 1/16	14 1/4	4
TH3225	14 1/2	35 1/8	5 5/16	15 1/4	6
TH3226	24 5/8	59 9/16	8 3/8	25 3/4	6
TH3325	23 1/4	50 7/8	8 3/8	24 1/4	6
TH3326	23 1/4	50 7/8	8 3/8	24 1/4	6
TH4321	6 1/2	10 3/8	3 3/8	7 1/8	1
TH4322	9 1/2	17 5/8	5	10 1/8	3
TH4323	9 1/2	21 3/8	5	10 1/8	3
TH4324	13 5/8	31 5/8	5 1/4	14 1/2	4
TH4325	23 1/4	50 7/8	8 3/8	24 1/4	6
TH4326	23 1/4	50 7/8	8 3/8	24 1/4	6
TH2261DC	8 5/8	12 5/8	4	9 1/2	15
TH2262DC	9 1/2	21 3/8	5	10 1/8	3
TH2263DC	9 1/2	22 3/4	5	10 1/8	14
TH3361	8 5/8	12 5/8	4	9 1/2	15
TH3362	9 1/2	21 3/8	5	10 1/8	3
TH3363	9 1/2	22 3/4	5	10 1/8	14
TH3364	13 5/8	31 5/8	5 1/4	14 1/2	4
TH3365	23 1/4	54	8 3/8	24 1/2	6
TH3366	23 1/4	54	8 3/8	24 1/2	6
THN2261DC	8 1/2	10 9/16	4	9 1/4	15
THN2262DC	9 1/2	17 5/8	5	10 1/8	3
THN2263DC	9 1/2	17 5/8	5	10 1/8	3
THN3321	6 1/2	10 3/8	3 3/8	7 1/8	1
THN3361	8 1/2	10 9/16	4	9 1/4	15
THN3362	9 1/2	17 5/8	5	10 1/8	3
THN3363	9 1/2	17 5/8	5	10 1/8	3
THN3364	13 5/8	31 5/8	5 1/4	14 1/2	4
THN3365	23 1/4	42 1/2	8 3/8	24 1/2	6
THN3366	23 1/4	42 1/2	8 3/8	24 1/2	6

<sup>1</sup>See page 2-33.

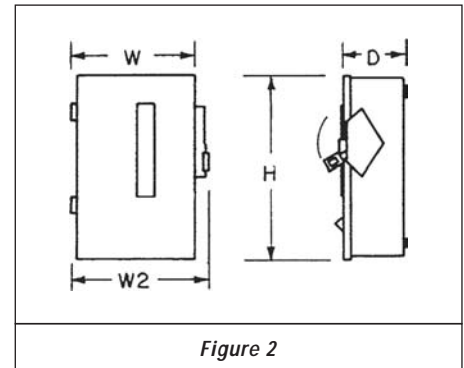

Figure 2

**Publications and Reference:** See Section 21  
for a list of additional product-related publications



## Enclosure Dimensions

### Spec-Setter Safety Switches

#### TG and TH, NEMA Type 1 and 3R Enclosures

#### NEMA Type 3R TG Approximate Dimensions in Inches Figure 3

Product Number	Dimension W	Dimension H	Dimension D	Dimension W2	KO Figure Number <sup>1</sup>
TG3221R	6 7/8	9 7/8	3 5/16	7 1/4	8
TG3222R	8 3/4	13 3/4	4	9 1/4	19
TG3223R	9 7/8	21 1/4	5	10	10
TG3224R	14	29	5 3/8	14 1/4	11
TG3225R	22 1/4	49 1/2	9	22 1/2	12
TG3226R	23 5/8	50	9 1/4	23 3/4	13
TG3325R	22 1/4	49 1/2	9	22 1/2	12
TG3326R	23 5/8	50	9 1/4	23 3/4	13
TG4321R	6 7/8	9 7/8	3 5/16	7 1/4	8
TG4322R	8 3/4	13 3/4	4	9 1/4	19
TG4323R	9 7/8	21 1/4	5	10	10
TG4324R	14	29	5 3/8	14 1/4	11
TGN3321R	6 7/8	9 7/8	3 5/16	7 1/4	8
TGN3322R	8 3/4	13 3/4	4	9 1/4	19
TGN3323R	9 7/8	15 3/4	5	10	10
TGN3324R	14	29	5 3/8	14 1/4	11

<sup>1</sup>See page 2-33.

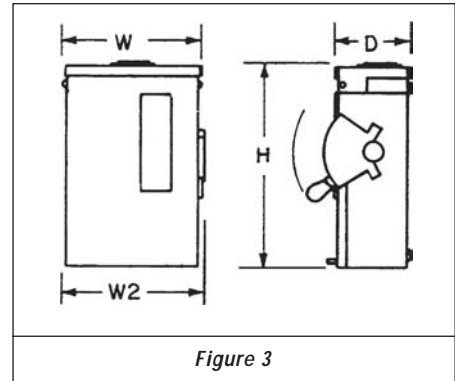

Figure 3

#### NEMA Type 3R TH Approximate Dimensions in Inches Figure 4

Product Number	Dimension W	Dimension H	Dimension D	Dimension W2	KO Figure Number <sup>1</sup>
TH3221R	6 7/8	10 5/8	3 5/16	7 1/8	8
TH3222R	9 3/8	19 3/8	5 1/16	10 1/4	10
TH3223R	13 1/2	25 3/8	5 1/16	14 1/4	10
TH3224R	14 1/2	35 1/8	5 5/16	15 1/4	11
TH3225R	24 5/8	59 9/16	8 3/8	25 3/4	18
TH3226R	23 1/2	53 1/4	8 3/8	24 1/4	18
TH3325R	23 1/2	49 1/8	8 3/8	24 1/4	18
TH3326R	23 1/2	53 1/4	8 3/8	24 1/4	18
TH4321R	6 7/8	10 5/8	3 5/16	7 1/8	8
TH4322R	9 7/8	17 1/2	5	10 1/8	10
TH4323R	9 7/8	22 1/4	5	10 5/8	10
TH4324R	14	31 1/2	5 5/16	14 1/8	11
TH2261RDC	8 7/8	13 1/4	4	9 1/2	19
TH2262RDC	9 7/8	22 1/4	5	10 5/8	10
TH2263RDC	9 7/8	22 1/4	5	10 5/8	10
TH3361R	8 7/8	13 1/4	4	9 1/2	19
TH3361RF	10 2/5	15	4 1/8	11 3/10	-
TH3361RF2	13 2/5	22 1/2	5 1/8	14 3/8	-
TH3362R	9 7/8	22 1/4	5	10 5/8	10
TH3362RF	13 2/5	22 1/2	5 1/8	14 3/8	-
TH3363R	9 7/8	22 1/4	5	10 5/8	10
TH3364R	14	31 1/2	5 5/16	14 1/8	11
TH3365R	23 1/2	53 1/4	8 3/8	24 1/4	18
TH3366R	23 1/2	53 1/4	8 3/8	24 1/4	18
THN2261RDC	8 7/8	13 1/4	4	9 1/2	19
THN2262RDC	9 7/8	17 1/2	5	10 1/8	10
THN2263RDC	9 7/8	17 1/2	5	10 1/8	10
THN3361R	8 7/8	13 1/4	4	9 1/2	19
THN3361RF	10 2/5	15	4 1/8	11 3/10	-
THN3362R	9 7/8	17 1/2	5	10 1/8	10
THN3362RF	13 2/5	22 1/2	5 1/8	14 3/8	-
THN3363R	9 7/8	17 1/2	5	10 1/8	10
THN3364R	14	31 1/2	5 5/16	14 1/8	11
THN3365R	23 1/2	49 1/8	8 3/8	24 1/4	18
THN3366R	23 1/2	53 1/4	8 3/8	24 1/4	18

<sup>1</sup>See page 2-33.

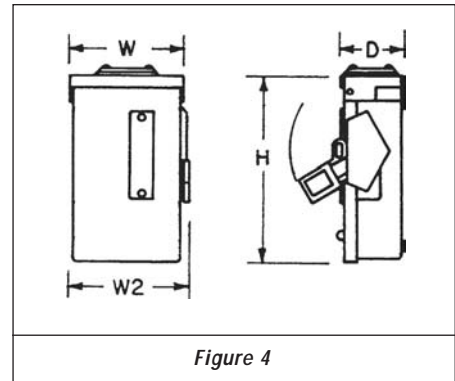

Figure 4



# Knockouts

Spec-Setter Safety Switches

TG and TH, NEMA Type 1 and 3R Enclosures

## Dimensions—Knockouts

Symbol	A	B	C	D	E	F	G	H	J	K	L	M	N
Conduit Size (Inches)	5/32	1/2	1/2	1/2	1/2	3/4	3/4	1	1	1 1/4	1 1/2	2	2 1/2
	—	—	3/4	3/4	3/4	1	1	1 1/4	1 1/2	2	3	3	—
	—	—	—	1	1	—	1 1/4	1 1/2	2	2 1/2	—	3 1/2	—

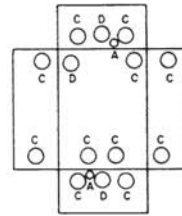

Fig. 1

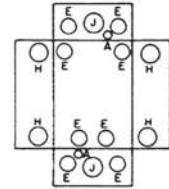

Fig. 2

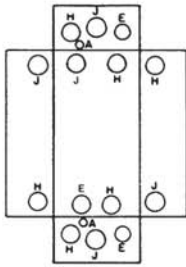

Fig. 3

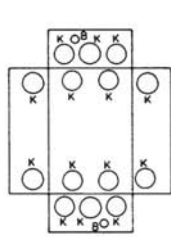

Fig. 4

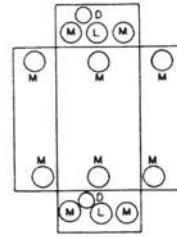

Fig. 5

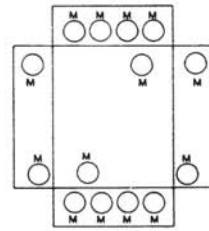

Fig. 6

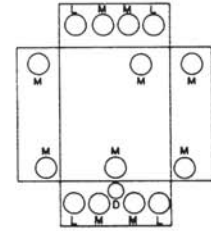

Fig. 7

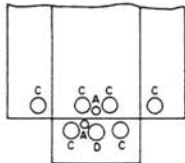

Fig. 8

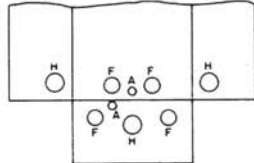

Fig. 9

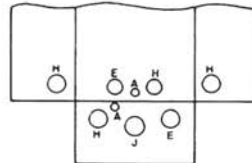

Fig. 10

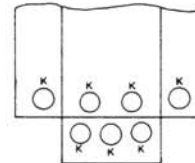

Fig. 11

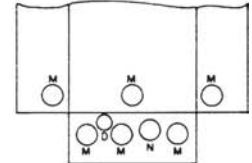

Fig. 12

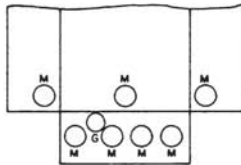

Fig. 13

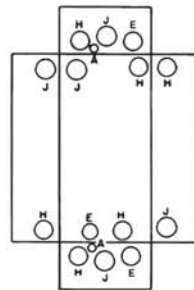

Fig. 14

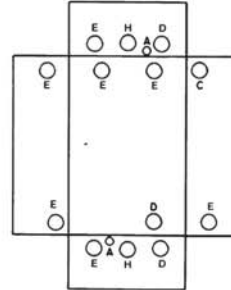

Fig. 15

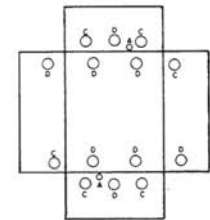

Fig. 16

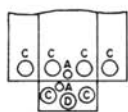

Fig. 17

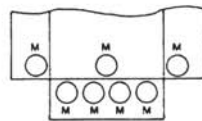

Fig. 18

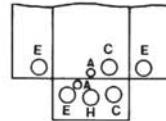

Fig. 19

Publications and Reference: See Section 21 for a list of additional product-related publications



## Enclosure Dimensions

### Spec-Setter Safety Switches

#### TH NEMA Type 4/4X, 12 and Mill Duty Enclosures

#### NEMA Type 4/4X TH Approximate Dimensions in Inches Figure 1

Product Number	Dimension W	Dimension H	Dimension D	Dimension W2
TH2221SS	7 3/8	11 3/8	5 1/16	8 1/8
TH2222SS	9 3/8	19 3/8	5 1/16	10 1/4
TH2261SSDC	9 3/8	13 3/8	5 5/16	10 1/4
TH2262SSDC	9 3/8	19 3/8	5 5/16	10 1/4
TH2263SSDC	13 1/2	25 3/8	5 5/16	14 1/4
TH3221SS	7 3/8	11 3/8	5 1/16	8 1/8
TH3222SS	9 7/8	17 1/2	5	10 1/8
TH3223SS	9 7/8	22 1/4	5	10 5/8
TH3224SS	14	31 1/2	5 5/16	14 1/8
TH3225SS	23 1/2	49 1/8	8 3/8	24 1/4
TH3226SS	24 5/8	59 9/16	8 3/8	25 3/4
TH3321SS	7 3/8	11 3/8	5 5/16	8 1/8
TH3322SS	9 3/8	19 3/8	5 5/16	10 1/4
TH3361SS	9 3/8	13 3/8	5 5/16	10 1/4
TH3362SS	9 3/8	19 3/8	5 5/16	10 1/4
TH3363SS	13 1/2	25 3/8	5 5/16	14 1/4
TH3364SS	14 1/2	35 1/8	5 5/16	15 1/4
TH3365SS	24 5/8	59 9/16	8 3/8	25 3/4
TH3366SS	24 5/8	59 9/16	8 3/8	25 3/4
TH4321SS	7 3/8	11 3/8	5 1/16	8 1/8
TH4322SS	9 3/8	19 3/8	5 1/16	10 1/4
TH4323SS	13 1/2	25 3/8	5 1/16	14 1/4
TH4324SS	13 1/2	35 1/8	5 5/16	15 1/4
TH4325SS	24 5/8	59 9/16	8 3/8	25 3/4
TH4326SS	24 5/8	59 9/16	8 3/8	25 3/4
THN2261SSDC	9 3/8	13 3/8	5 1/16	10 1/4
THN2262SSDC	9 3/8	19 3/8	5 1/16	10 1/4
THN2263SSDC	13 1/2	25 3/8	5 5/16	14 1/4
THN3361SS	9 3/8	13 3/8	5 1/16	10 1/4
THN3362SS	9 3/8	19 3/8	5 1/16	10 1/4
THN3363SS	13 1/2	25 3/8	5 5/16	14 1/4
THN3364SS	14 1/2	35 1/8	5 5/16	15 1/4
THN3365SS	24 5/8	59 9/16	8 3/8	25 3/4
THN3366SS	24 5/8	59 9/16	8 3/8	25 3/4

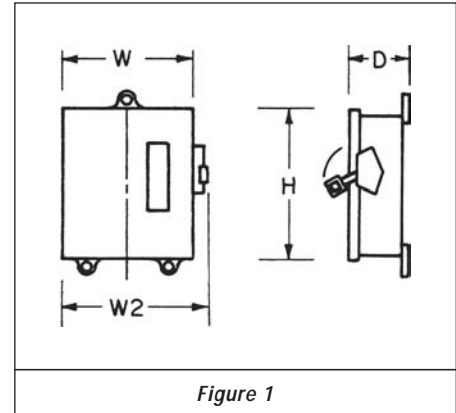

Figure 1

#### NEMA Type 12 TH Approximate Dimensions in Inches Figure 1

Product Number	Dimension W	Dimension H	Dimension D	Dimension W2
TH2221J	7 3/8	11 3/8	5 1/16	8 1/8
TH2222J	9 3/8	19 3/8	5 1/16	10 1/4
TH2261JDC	9 3/8	13 3/8	5 5/16	10 1/4
TH2262JDC	9 3/8	19 3/8	5 5/16	10 1/4
TH2263JDC	13 1/2	25 3/8	5 5/16	14 1/4
TH3221J	7 3/8	11 3/8	5 1/16	8 1/8
TH3222J	23 1/4	50 7/8	8 3/8	24 1/4
TH3223J	9 1/2	21 3/8	5	10 1/8
TH3224J	13 5/8	31 5/8	5 1/4	14 1/2
TH3225J	23 1/4	50 7/8	8 3/8	24 1/4
TH3226J	24 5/8	59 9/16	8 3/8	25 3/4
TH3321J	7 3/8	11 3/8	5 5/16	8 1/8
TH3322J	9 3/8	19 3/8	5 5/16	10 1/4
TH3361J	9 3/8	13 3/8	5 5/16	10 1/4
TH3362J	9 3/8	19 3/8	5 5/16	10 1/4
TH3363J	13 1/2	25 3/8	5 5/16	14 1/4
TH3364J	14 1/2	35 1/8	5 5/16	15 1/4
TH3365J	24 5/8	59 9/16	8 3/8	25 3/4
TH3366J	24 5/8	59 9/16	8 3/8	25 3/4
TH4321J	7 3/8	11 3/8	5 1/16	8 1/8
TH4322J	9 3/8	19 3/8	5 1/16	10 1/4
TH4323J	13 1/2	25 3/8	5 1/16	14 1/4
TH4324J	13 1/2	35 1/8	5 5/16	15 1/4
TH4325J	24 5/8	59 9/16	8 3/8	25 3/4
TH4326J	24 5/8	59 9/16	8 3/8	25 3/4
THN2261JDC	9 3/8	13 3/8	5 1/16	10 1/4
THN2262JDC	9 3/8	19 3/8	5 1/16	10 1/4
THN2263JDC	13 1/2	25 3/8	5 5/16	14 1/4
THN3361J	9 3/8	13 3/8	5 1/16	10 1/4
THN3362J	9 3/8	19 3/8	5 1/16	10 1/4
THN3363J	13 1/2	25 3/8	5 5/16	14 1/4
THN3364J	14 1/2	35 1/8	5 5/16	15 1/4
THN3365J	24 5/8	48 1/16	8 3/8	25 3/4
THN3366J	24 5/8	48 1/16	8 3/8	25 3/4



## Enclosure Dimensions

### Spec-Setter Safety Switches

#### TH NEMA Type 4/4X, 12 and Mill Duty Enclosures

**Mill Duty TH Approximate Dimensions in Inches Figure 1**

Product Number	Dimension W	Dimension H	Dimension D	Dimension W2
TH2221M	7 3/8	11 3/8	5 1/16	9 1/4
TH2222M	9 3/8	19 3/8	5 1/16	11 1/4
TH2223M	13 1/2	25 3/8	5 1/16	15 1/4
TH2224M	14 1/2	35 1/8	5 5/16	16 1/4
TH2221MSS	7 3/8	11 3/8	5 1/16	9 1/4
TH2222MSS	9 3/8	19 3/8	5 1/16	11 1/4
TH2223MSS	13 1/2	25 3/8	5 1/16	15 1/4
TH2224MSS	14 1/2	35 1/8	5 5/16	16 1/4
TH2261MDC	9 3/8	19 3/8	5 5/16	11 1/4
TH2262MDC	9 3/8	19 3/8	5 5/16	11 1/4
TH2263MDC	13 1/2	25 3/8	5 5/16	15 1/4
TH2261MSSDC	9 3/8	19 3/8	5 5/16	11 1/4
TH2262MSSDC	9 3/8	19 3/8	5 5/16	11 1/4
TH2263MSSDC	13 1/2	25 3/8	5 5/16	15 1/4
TH3321M	7 3/8	11 3/8	5 1/16	9 1/4
TH3322M	9 3/8	19 3/8	5 1/16	11 1/4
TH3323M	13 1/2	25 3/8	5 1/16	15 1/4
TH3324M	14 1/2	35 1/8	5 5/16	16 1/4
TH3325M	24 5/8	59 9/16	8 3/8	25 3/4
TH3326M	24 5/8	59 9/16	8 3/8	25 3/4
TH3321MSS	7 3/8	11 3/8	5 1/16	9 1/4
TH3322MSS	9 3/8	19 3/8	5 1/16	11 1/4
TH3323MSS	13 1/2	25 3/8	5 1/16	15 1/4
TH3324MSS	14 1/2	35 1/8	5 5/16	16 1/4
TH3325MSS	24 5/8	59 9/16	8 3/8	25 3/4
TH3326MSS	24 5/8	59 9/16	8 3/8	25 3/4
TH3361M	9 3/8	19 3/8	5 5/16	11 1/4
TH3362M	9 3/8	19 3/8	5 5/16	11 1/4
TH3363M	13 1/2	25 3/8	5 5/16	15 1/4
TH3364M	14 1/2	35 1/8	5 5/16	16 1/4
TH3365M	24 5/8	59 9/16	8 3/8	25 3/4
TH3366M	24 5/8	59 9/16	8 3/8	25 3/4
TH3361MSS	9 3/8	19 3/8	5 5/16	11 1/4
TH3362MSS	9 3/8	19 3/8	5 5/16	11 1/4
TH3363MSS	13 1/2	25 3/8	5 5/16	15 1/4
TH3364MSS	14 1/2	35 1/8	5 5/16	16 1/4
TH3365MSS	24 5/8	59 9/16	8 3/8	25 3/4
TH3366MSS	24 5/8	59 9/16	8 3/8	25 3/4
THN2261MDC	9 3/8	13 3/8	5 5/16	11 1/4
THN2262MDC	9 3/8	19 3/8	5 5/16	11 1/4
THN2263MDC	13 1/2	25 3/8	5 5/16	15 1/4
THN2261MSSDC	9 3/8	13 3/8	5 5/16	11 1/4
THN2262MSSDC	9 3/8	19 3/8	5 5/16	11 1/4
THN2263MSSDC	13 1/2	25 3/8	5 5/16	15 1/4
THN3361M	9 3/8	19 3/8	5 5/16	11 1/4
THN3362M	9 3/8	19 3/8	5 5/16	11 1/4
THN3363M	13 1/2	25 3/8	5 5/16	15 1/4
THN3364M	14 1/2	35 1/8	5 5/16	16 1/4
THN3361MSS	9 3/8	19 3/8	5 5/16	11 1/4
THN3362MSS	9 3/8	19 3/8	5 5/16	11 1/4
THN3363MSS	13 1/2	25 3/8	5 5/16	15 1/4
THN3364MSS	14 1/2	35 1/8	5 5/16	16 1/4
THN3365M	24 5/8	48 1/16	8 3/8	25 3/4
THN3365MSS	24 5/8	59 9/16	8 3/8	25 3/4
THN3366M	24 5/8	48 1/16	8 3/8	25 3/4
THN3366MSS	24 5/8	59 9/16	8 3/8	25 3/4

**Publications and Reference:** See Section 21  
for a list of additional product-related publications



## Enclosure Dimensions

Spec-Setter Safety Switches

TH NEMA Type 4/4X, 12 and Mill Duty Enclosures

### Copper Lug THR Approximate Dimensions in Inches Figure 1

Product Number	Dimension W	Dimension H	Dimension D	Dimension W2
THR3361JCL	9 3/8	19 3/8	5 5/16	10 1/4
THR3362JCL	9 3/8	19 3/8	5 5/16	10 1/4
THR3363JCL	13 1/2	25 3/8	5 5/16	14 1/4
THR3364JCL	14 1/2	35 1/8	5 5/16	15 1/4
THR3365JCL	24 5/8	59 9/16	8 3/8	25 3/4
THR3366JCL	24 5/8	59 9/16	8 3/8	25 3/4
THN3361JCL	9 3/8	19 3/8	5 5/16	10 1/4
THN3362JCL	9 3/8	19 3/8	5 5/16	10 1/4
THN3363JCL	13 1/2	25 3/8	5 5/16	14 1/4
THN3364JCL	14 1/2	35 1/8	5 5/16	15 1/4
THN3365JCL	24 5/8	48 1/16	8 3/8	25 3/4
THN3366JCL	24 5/8	48 1/16	8 3/8	25 3/4

### 6-pole TH Approximate Dimensions in Inches Figure 1

Product Number	Dimension W	Dimension H	Dimension D	Dimension W2
TH6621	19	14 5/8	6	19 3/4
TH6622	19	24 1/8	6	19 3/4
TH6623	19	24 1/8	6	19 3/4
TH6624	26 1/4	35 3/8	6	27
TH6661	19	14 5/8	6	19 3/4
TH6662	19	24 1/8	6	19 3/4
TH6663	19	24 1/8	6	19 3/4
TH6664	26 1/4	35 3/8	6	27
THN6661	19	14 5/8	6	19 3/4
THN6662	19	24 1/8	6	19 3/4
THN6663	19	24 1/8	6	19 3/4
THN6664	26 1/4	35 3/8	6	27

### Receptacle TH Approximate Dimensions in Inches Figure 2

Product Number	Dimension W	Dimension H	Dimension D	Dimension W2
TH3362JCH	9 3/8	19 3/8	5 5/16	10 1/4
THN3362JCH	9 3/8	19 3/8	5 5/16	10 1/4

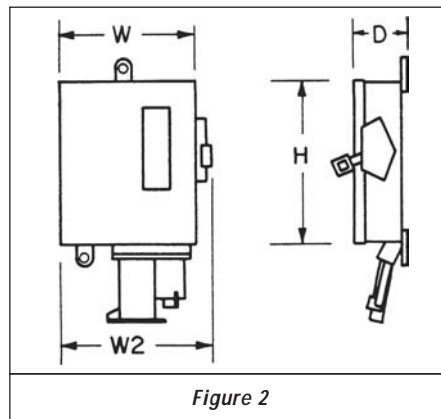

## Enclosure Dimensions

### Spec-Setter Safety Switches

#### TC, TDT, TPF and TPN

#### NEMA Type 1 and 3R Enclosures

#### NEMA Type 1 TC, Plug Fuse Approximate Dimensions in Inches Figure 1

Product Number	Dimension W	Dimension H	Dimension D	Dimension W2	KO Figure Number <sup>1</sup>
TPF130	4 3/8	7 5/8	2 1/2	4 3/8	17
TPF230	4 3/8	7 5/8	2 1/2	4 3/8	17

<sup>1</sup>See page 2-39.

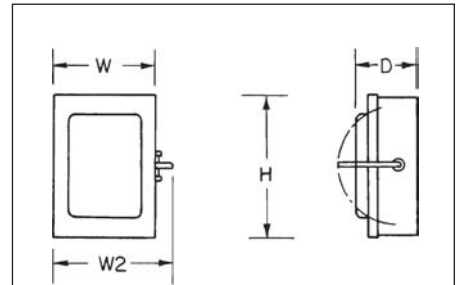

Figure 1

#### NEMA Type 1 TC Double Throw Approximate Dimensions in Inches Figure 1

Product Number	Dimension W	Dimension H	Dimension D	Dimension W2	KO Figure Number <sup>1</sup>
TC35321	10 3/8	11 15/16	4 1/16	12	7
TC35322	11 3/8	15 1/4	5 1/16	13 1/8	8
TC35323	14 3/8	22 3/8	6 1/16	16 3/8	9
TC35324	17 7/8	30 1/8	6 7/8	19 7/8	10
TC35325	20 7/16	34 5/16	8 1/4	22 15/16	11
TC35326	23 1/2	44 3/8	9 1/4	26	12
TC35362	10 3/8	11 15/16	4 1/16	12	8
TC35363	14 3/8	22 3/8	6 1/16	16 3/8	9
TC35364	17 7/8	30 1/8	6 7/8	19 7/8	10
TC35365	20 7/16	34 5/16	8 1/4	22 15/16	11
TC35366	23 1/2	44 3/8	9 1/4	26	12

<sup>1</sup>See page 2-39.

#### NEMA Type 1 TDT Fusible Double Throw Approximate Dimensions in Inches Figure 5

Product Number	Dimension W	Dimension H	Dimension D	Dimension W2	KO Figure Number <sup>1</sup>
TDT3321	-	37	9 7/8	12 3/4	No KO
TDT3322	-	37	9 7/8	12 3/4	No KO
TDT3323	-	37	9 7/8	12 3/4	No KO
TDT3324	-	51 3/8	11 1/4	20 3/8	No KO
TDT3325	-	74 3/4	14 1/8	26 1/8	No KO
TDT3326	-	86 1/8	14 1/8	28 1/4	No KO
TDT3361	-	37	9 7/8	12 3/4	No KO
TDT3362	-	37	9 7/8	12 3/4	No KO
TDT3363	-	37	9 7/8	12 3/4	No KO
TDT3364	-	51 3/8	11 1/4	20 3/8	No KO
TDT3365	-	74 3/4	14 1/8	26 1/8	No KO

<sup>1</sup>See page 2-39.

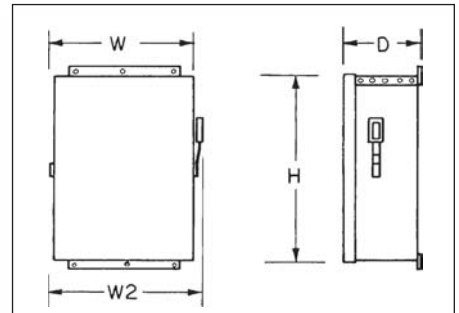

Figure 2

#### NEMA Type 1 TC 800 and 1200 Amp Approximate Dimensions in Inches Figure 2

Product Number	Dimension W	Dimension H	Dimension D	Dimension W2	KO Figure Number <sup>1</sup>
TC36367	32 1/4	52 1/2	12 1/2	34	No KO
TC36368	37 1/2	65 1/2	13 1/2	39 1/4	No KO
TC72267	41 3/4	62	12 1/2	43 1/2	No KO
TC72268	47 1/2	77	13 1/2	49 1/4	No KO
TC72367	41 3/4	62	12 1/2	43 1/2	No KO
TC72368	47 1/2	77	13 1/2	49 1/4	No KO

<sup>1</sup>See page 2-39.

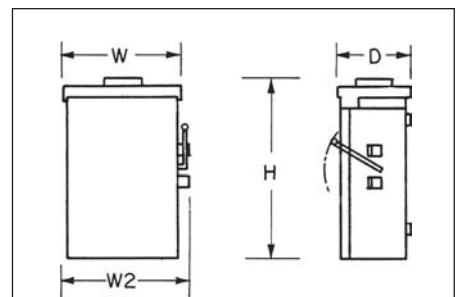

Figure 3

#### NEMA Type 3R TC Double Throw Approximate Dimensions in Inches Figure 3

Product Number	Dimension W	Dimension H	Dimension D	Dimension W2	KO Figure Number <sup>1</sup>
TC10323R	7 3/8	15 1/8	4	8 1/16	15
TC10324R	13 9/16	30	6 1/4	15 5/8	13
TC10424R	13 9/16	30	6 1/4	15 5/8	13

<sup>1</sup>See page 2-39.

#### NEMA Type 3R TDT Fusible Double Throw Approximate Dimensions in Inches Figure 5

Product Number	Dimension W	Dimension H	Dimension D	Dimension W2	KO Figure Number <sup>1</sup>
TDT3321R	-	37	9 7/8	12 3/4	No KO
TDT3322R	-	37	9 7/8	12 3/4	No KO
TDT3323R	-	37	9 7/8	12 3/4	No KO
TDT3324R	-	51 3/8	11 1/4	20 3/8	No KO
TDT3363R	-	37	9 7/8	12 3/4	No KO
TDT3364R	-	51 3/8	11 1/4	20 3/8	No KO

<sup>1</sup>See page 2-39.

Publications and Reference: See Section 21 for a list of additional product-related publications





## Enclosure Dimensions

Spec-Setter Safety Switches

TC, TDT, TPF and TPN

NEMA Type 1 and 3R Enclosures

### NEMA Type 3R TC 800 and 1200 Amp Approximate Dimensions in Inches Figure 2

Product Number	Dimension W	Dimension H	Dimension D	Dimension W2	KO Figure Number
TC72267R	41 3/4	62	12 1/2	43 1/2	No KO
TC72268R	47 1/2	77	13 1/2	49 1/4	No KO
TC72367R	41 3/4	62	12 1/2	43 1/2	No KO
TC72368R	47 1/2	77	13 1/2	49 1/4	No KO

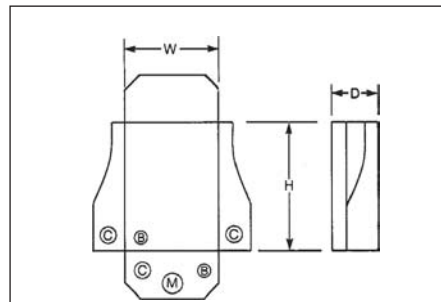

Figure 4

### NEMA Type 3R TP AC Disconnect Approximate Dimensions in Inches Figure 4

Product Number	Dimension W	Dimension H	Dimension D	Dimension W2	KO Figure Number <sup>1</sup>
TPF30R	5 3/4	8	3 1/8	-	5
TPF60R	5 3/4	8	3 1/8	-	5
TPN60R1	5	7 1/4	2 1/8	-	5
TPNA60R1	5	7 1/4	2 1/8	-	5

<sup>1</sup>See page 2-39.

### NEMA Type 3R TF AC Disconnect Approximate Dimensions in Inches Figure 5

Product Number	Dimension W	Dimension H	Dimension D	Dimension W2	KO Figure Number <sup>1</sup>
TF30R	4 3/4	7 1/2	2	-	16
TF60R	6 1/2	9	3 1/4	-	16
TFN60R	4 3/4	7 1/2	2	-	16
TFN60RGFR	5 3/4	7 1/8	5 3/16	-	16

<sup>1</sup>See page 2-39.

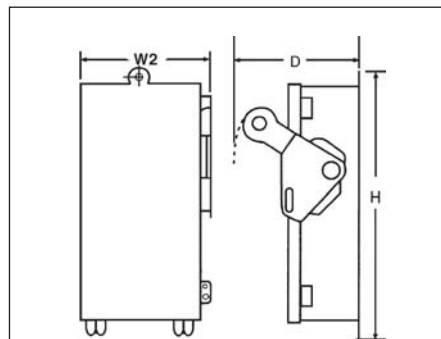

Figure 5

### NEMA Type 3R TN AC Disconnect Approximate Dimensions in Inches Figure 5

Product Number	Dimension W	Dimension H	Dimension D	Dimension W2	KO Figure Number <sup>1</sup>
TNA60R1	4 3/4	7 1/2	2	-	16
TNA60RGFR	5 3/4	7 1/8	5 3/16	-	16

<sup>1</sup>See page 2-39.

SAFETY SWITCHES

2



# Knockouts

Spec-Setter Safety Switches  
 TC, TDT, TPF and TPN  
 NEMA Type 1 and 3R Enclosures

Symbol	A	B	C	D	E	F	G	H	J	K	L	M	N
Conduit Size (Inches)	1/2	1/2	3/4	1/2	3/4	1	1 1/4	2	2 1/2	2	3	1	3/4
	—	3/4	1	3/4	1	1 1/4	1 1/2	2 1/2	3	2 1/2	3 1/2	1 1/4	—
	—	—	—	1	1 1/4	1 1/2	2	—	—	3	—	—	—

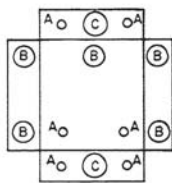

Fig. 6

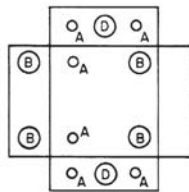

Fig. 7

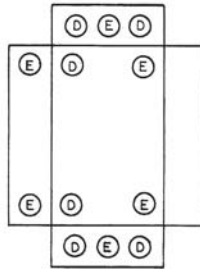

Fig. 8

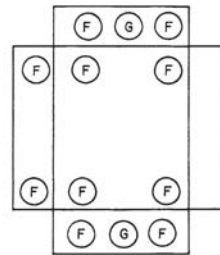

Fig. 9

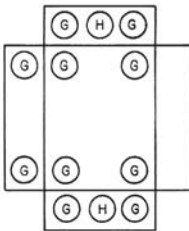

Fig. 10

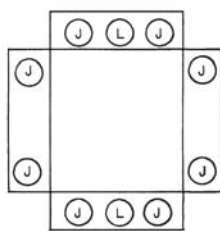

Fig. 11

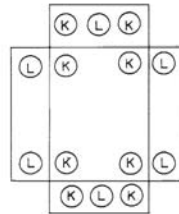

Fig. 12

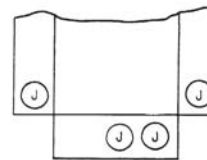

Fig. 13

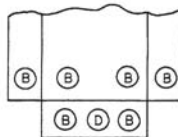

Fig. 14

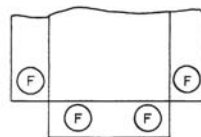

Fig. 15

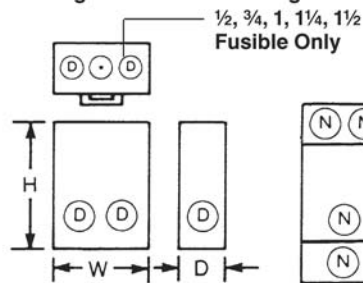

Fig. 16

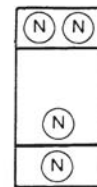

Fig. 17

Publications and Reference: See Section 21 for a list of additional product-related publications



## Low Voltage Construction Fuses

GE Consumer and Industrial Fuse Program in partnership with Ferraz Shawmut

Contact your local GE Consumer and Industrial sales representative for fuse applications, specification, and sizing assistance.

### 600V CLASS J T-D AJT

#### Features and Benefits

- Solid State SmartSpot Indicator
- Time delay for motor starting and transformer inrush
- 300kA interrupting rating - self-certified, UL witnessed tests
- Low peak let-thru current
- Current limiting UL class fuse
- Small footprint requires less mounting space and allows smaller, more economical fuse blocks
- Easy 2-to-1 selectivity helps prevent nuisance shutdowns
- Unique Class J dimensions help prevent replacement errors
- Metal-embossed date and product number for traceability and lasting identification
- Fiberglass body provides dimensional stability in harsh industrial settings
- High-grade silica filler designed for fast arc quenching
- Optional EI Indicator/Switch mount for AJT70 to 600 open fuse indication

#### Ratings

- AC: 1 to 600A, 600 Vac, 200kA I.R. (self-certified for 600 Vac, 300kA I.R., UL witnessed)
- DC: 1 to 600A, 500 Vdc, 100kA I.R.



### 600V CLASS J T-D A4BQ

#### Features and Benefits

- Faster operation under short circuit conditions: Let-thru currents are typically 20% lower, with a corresponding let-thru energy (clearing  $I^2t$ ) up to 40% lower than the next fastest Class L fuse
- Time delay for high inrush loads such as motors and transformers, without nuisance opening
- 300kA interrupting rating - self-certified, UL witnessed tests
- Extremely current limiting for lower peak let-thru current.
- Pure silver links ensure low let-thru current and longer fuse life
- Easy 2-to-1 selectivity helps prevent nuisance shutdowns and “blackouts”
- Rejection-style design deters replacement errors
- Helps reduce inventory because A4BQ can replace all older types of Class L fuses now in service
- Metal-embossed date and product number for traceability and lasting identification
- Fiberglass body provides dimensional stability in harsh industrial settings
- High-grade silica filler designed for fast arc quenching

#### Ratings

- AC: 100 to 6000A, 600 Vac, 200kA I.R. (self-certified for 600 Vac, 300kA I.R., UL witnessed)  
4-second delay at 500% rating. Note: 100-600A ratings are non-listed
- DC: 601 to 3000A, 600 Vdc, 100kA I.R.



### 600V CLASS L A4BY

#### Features and Benefits

- Unique dimensions help prevent replacement by other fuse classes
- Blade stamped product numbers for permanent identification
- Glass melamine body and plated terminals provide superior reliability in harsh environments

#### Ratings

- AC: 200 to 6,000A  
600 Vac, 200kA I.R.
- DC: 200 to 2500A  
300 Vdc, 100kA I.R.



SmartSpot, AmpTrap and UltraSafe are trademarks, and Tri-onic is a registered trademark of Ferraz Shawmut.



## Low Voltage Construction Fuses

GE Consumer and Industrial Fuse Program in partnership with Ferraz Shawmut

Contact your local GE Consumer and Industrial sales representative for fuse applications, specification, and sizing assistance.

### 250 and 600V ONE TIME OT and OTS

#### Features and Benefits

- Easy to read imprint label for quick recognition and replacement
- Low cost

#### Ratings

- OT
  - AC: 1 to 600A, 250 Vac, 50kA I.R.
  - DC: 1 to 600A, 250 Vdc, 20kA I.R.
- OTN (Canada)
  - AC: 15 to 60A, 250 Vac, 50kA I.R.
- OTS
  - AC: 1 to 600A, 600 Vac, 50kA I.R.
  - DC: 1 to 600A, 300 Vdc, 20kA I.R.



### 300 and 600V CLASS T A3T and A6T

#### Features and Benefits

- Low peak let-thru current
- Unique dimensions designed to prevent replacement by other fuse classes
- Blade-stamped product numbers for permanent identification
- Small physical size for greater design flexibility

#### Ratings

- A3T
  - AC: 1 to 1200A, 300 Vac, 200kA I.R.
  - DC: 1 to 1200A, 160 Vdc, 50kA I.R.
- A6T
  - AC: 1 to 800A, 600 Vac, 200kA I.R.
  - DC: 1 to 800A, 300 Vdc, 100kA I.R.



### 600V CLASS J F-A A4J

#### Features and Benefits

- High current limitation for low peak let-thru current
- Unique dimensions designed to prevent replacement by other fuse classes
- Fiberglass body provides dimensional stability in harsh industrial environments
- Easy-to-read imprint label for quick recognition and replacement

#### Ratings

- AC: 1 to 600A, 600 Vac, 200kA I.R.
- DC: 1 to 600A, 300 Vdc, 20kA I.R.



**Publications and Reference:** See Section 21 for a list of additional product-related publications



## Low Voltage Construction Fuses

GE Consumer and Industrial Fuse Program in partnership with Ferraz Shawmut

Contact your local GE Consumer and Industrial sales representative for fuse applications, specification, and sizing assistance.

### 250 and 600V RK1 T-D A2D and A6D

#### Features and Benefits

- Solid State SmartSpot Indicator
- Time delay for motor starting and transformer inrush currents without nuisance opening
- 300kA interrupting rating - self-certified, UL witnessed tests
- Low peak let-thru current
- Easy 2-to-1 selectivity helps prevent nuisance shut downs and “black outs”
- Rejection-style design deters replacement errors (when used with recommended fuse blocks)
- Helps reduce inventory by taking the place of RK5, K, and H fuses
- Metal-embossed date and product number for easier traceability and lasting identification
- Fiberglass body provides dimensional stability in harsh industrial settings
- Brass end-caps (blade-style) for cooler operation and superior performance

#### Ratings

- A2D
  - AC: 1/10 to 600A, 250 Vac, 200kA I.R. (self-certified for 250 Vac, 300kA I.R., UL witnessed)
- A6D
  - AC: 1/10 to 600A, 600 Vac, 200kA I.R. (self-certified for 600 Vac, 300kA I.R.)



### 250 and 600V RK1 F-A A2K and A6K

#### Features and Benefits

- Rejection style design deters replacement by other fuse classes
- Fiberglass body provides dimensional stability in harsh industrial environments
- Easy-to-read imprint label for quick recognition and replacement
- High degree of current limitation for low peak let-thru current

#### Ratings

- A2K
  - AC: 1 to 600A, 250 Vac, 200kA I.R.
  - DC: 1 to 600A, 250 Vdc, 200kA I.R.
- A6K
  - AC: 1 to 600A, 600 Vac, 200kA I.R.
  - DC: 1 to 600A, 300 Vdc, 200kA I.R.



### 250 and 600V RK5 T-D TR-R and TRS-R

#### Features and Benefits

- Solid State SmartSpot Indicator
- Time delay for motor start-ups and transformer inrush currents without nuisance opening
- Current limiting for low peak let-thru current
- Rejection-style design deters replacement errors (when used with recommended fuse blocks)
- Easy-to-read label for quick recognition and replacement
- Metal-embossed date and product number for traceability and lasting identification
- Fiberglass body provides dimensional stability in harsh industrial settings
- Brass end-caps (blade-style) for cooler operation and superior performance
- High-grade silica filler designed for fast arc quenching and high current limitation

#### Ratings

- TR
  - AC: 1/10 to 600A, 250 Vac, 200kA I.R.
  - DC: 1/10 to 2 8/10A and 35 to 400A, 250 Vdc, 20kA I.R.; 3 to 30A and 450 to 600A, 160 Vdc, 20kA I.R.
- TRS
  - AC: 1/10 to 600A, 600 Vac, 200kA I.R.
  - DC: 1/10 to 12A, 600 Vdc, 20kA I.R.; 70 to 600A, 600 Vdc, 100kA I.R.; 15 to 60A, 300 Vdc, 20kA I.R.



SmartSpot, AmpTrap and UltraSafe are trademarks, and Tri-onic is a registered trademark of Ferraz Shawmut.



## Low Voltage Construction Fuses

GE Consumer and Industrial Fuse Program in partnership with Ferraz Shawmut

Contact your local GE Consumer and Industrial sales representative for fuse applications, specification, and sizing assistance.

### 250V and 600V FBs

#### Ratings

- 600 Vac, 30A
  - Min. voltage to operate indicator light: 90 Vac [Less than 0.7 mA leakage current at 600V]
- Special Indicator for 24 Vdc, 30A
- Special Indicator for 48 Vdc, 30A
- Withstand rating:
  - Class CC 200kA I.R.
  - Midget Fuse 100kA I.R.



### PDBs

#### Features and Benefits

- Finger-Safe
  - Fully insulated block. Recessed termination screws and wire openings provide IP20 grade protection and qualify as "finger-safe" per IEC 529.
- Compact Modularity
  - Single or multiple pole configurations in the most compact footprint. Allows users to build smaller or higher density panels.
- Snap on DIN Rail Mounting
  - Sizes 1 to 4 feature integral DIN rail adaptors allowing for quick and easy installations on 35mm DIN rail yielding lower installed costs.
- Captive Termination Screws
  - Unique channel design ensures captive metric wire termination screws. Screws can never be lost.
- Available Accessories
  - For multi-pole panel mounting, simply snap in pins for rigid fit. Cap plugs provide the ability to maintain touch safety on unused openings. Circuit identification markers simply snap into blocks to ID circuits. End anchors provide rigid end stops.



#### Ratings

- Ampere ratings from 175 to 840A
- 600V rated

**Publications and Reference:** See Section 21 for a list of additional product-related publications



